



Parts & Accessories



EATON 191

• DANA/EATON AXLES •



Track Length: 77-1/2" Rating: 25,000

Part Number	Bearing Combo Inner/Outer	Tube Size	Nominal Wall Thickness	28 Spline Cam Length	Brake Size
DANP22AX503T7703	HM518445/HM518410	5"	7/16"	23-3/8"	16-1/2" x 7"

1-800-621-7949

www.auroraparts.com

Various parts are listed for reference only. Contact Aurora Parts for nearest dealer. © 2007 Aurora Parts & Accessories



• ARVINMERITOR AXLES • AFTER MARKET IDENTIFICATION CHART

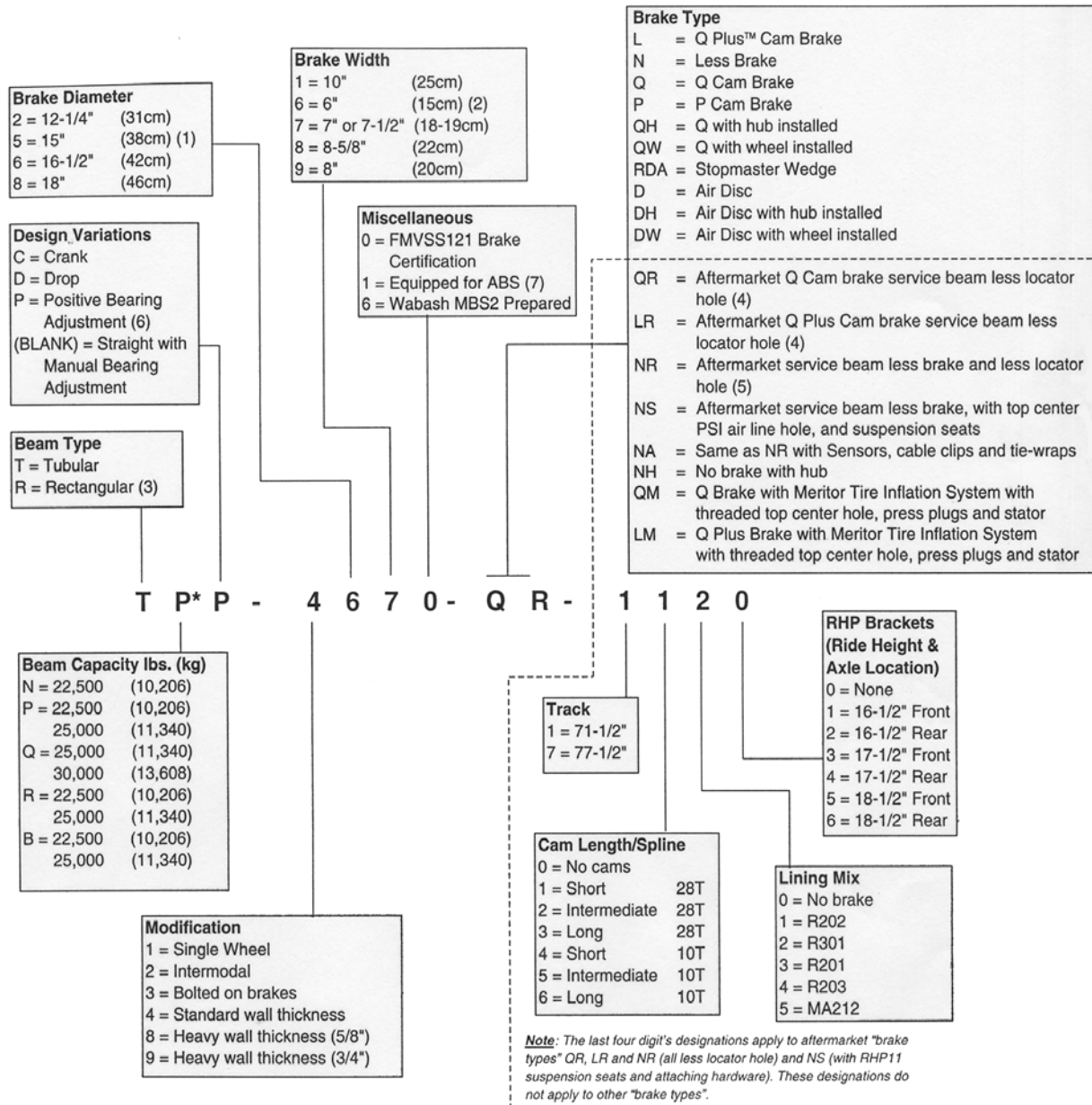

- (1) Drum or rotor
- (2) Denotes brake shoe width or pad size
- (3) Service beam only
- (4) Equipped with brake shoes and camshafts
- (5) Equipped with camshafts but no brake shoes
- (6) Not available in crank or drop center axles
- (7) Used on all NS axles

- * Bearings**
- N = HM218248 / HM212049
 - P = HM518445 / HM518445
 - Q = HM218248 / HM212049
 - R = 594A / 580
 - B = Unitized hub and bearings



AXLE BEAMS



5" round axle with cam brackets No brake shoes or cam shafts w/ other axle pedestals

Part Number	Track Length	Bearing Combo Inner/Outer	Rating	28 Spline Cam Length	Brake Size	ABS	Description
MTRWP-4671-NS-7101	77½"	HM518445/HM518410	22,500	17.38"	16½" × 7"	Yes	RHP11 Front axle
MTRWP-4671-NS-7102	77½"	HM518445/HM518410	22,500	17.38"	16½" × 7"	Yes	RHP11 Rear axle
MTRWP-8671-NS-7101	77½"	HM518445/HM518410	25,000	17.38"	16½" × 7"	Yes	RHP11 Front axle
MTRWP-8671-NS-7102	77½"	HM518445/HM518410	25,000	17.38"	16½" × 7"	Yes	RHP11 Rear axle

AXLES



5" Round Axles with brake shoes

Part Number	Track Length	Bearing Combo Inner/Outer	Rating	28 Spline Cam Length	Brake Size	ABS	Lining
MTRTN-4671-QR-1150	71½"	HM212049/HM218210	22,500	17.38"	16½" × 7" Q	Yes	MA212
MTRTN-4671-QR-1250	71½"	HM212049/HM218210	22,500	20.47"	16½" × 7" Q	Yes	MA212
MTRTN-4671-QR-7150	77½"	HM212049/HM218210	22,500	17.38"	16½" × 7" Q	Yes	MA212
MTRTN-4671-QR-7250	77½"	HM212049/HM218210	22,500	20.47"	16½" × 7" Q	Yes	MA212
MTRTQ-4671-QR-1250	71½"	HM212049/HM218210	25,000	20.47"	16½" × 7" Q	Yes	MA212
MTRTQ-4671-QR-1350	71½"	HM212049/HM218210	25,000	24.14"	16½" × 7" Q	Yes	MA212
MTRTQ-4671-QR-7350	77½"	HM212049/HM218210	25,000	24.14"	16½" × 7" Q	Yes	MA212
MTRTP-4671-QR-1150	71½"	HM518445/HM518410	22,500	17.38"	16½" × 7" Q	Yes	MA212
MTRTP-4671-QR-7150	77½"	HM518445/HM518410	22,500	17.38"	16½" × 7" Q	Yes	MA212
MTRTP-8671-QR-1350	71½"	HM518445/HM518410	25,000	24.14"	16½" × 7" Q	Yes	MA212
MTRTP-8671-QR-7350	77½"	HM518445/HM518410	25,000	24.14"	16½" × 7" Q	Yes	MA212
MTRTP-8671-LR-7350	77½"	HM518445/HM518410	25,000	24.14"	16½" × 7" Q+	Yes	MA212
MTRWP-4671-L-3079	77½"	HM518445/HM518410	22,500	19.38"	16½" × 7" Q	Yes	MA212
MTRWP-8671-L-3095	77½"	HM518445/HM518410	25,000	24.14"	16½" × 7" Q+	Yes	R201



Parts & Accessories

• PRO-PAR AXLES •

Key	Part Number	Description
1	FRUACF3379-1	XEM unlined shoe
	MTRSF5554515F3	XEM lined shoe assembly
2	FRUACF6608-2	Brake chamber bracket
3	FRUACF4024-900	Cam bracket kit
5	FRUACF3378-1	Brake anchor pin
6	FRU583015	Return spring pin
7	FRUACF3079-1	Anchor pin spring
8	FRUACF6414-1	HD return spring
9	FRUACD2233-1	Roller retainer
10	FRU330733	Brake shoe roller
11	FRUAXA0409-PK1	Cotter pin
12	FRUAXA0068	Anchor pin bushing
13	FRUACE8510-1	Axle nut
14	FRUAXA0408-1	Metal axle plug
15	FRUACD7180-1	Axle washer
16	FRUAXA0420-900	Cam bushing kit
17	FRUACD2285-900	37 SPL Slack Adjuster
18	-FRUAPA1283-1	37 SPL camshaft STD LH
	-FRUAPA1283-2	37 SPL camshaft STD RH
	-FRUAPA1283-3	37 SPL camshaft long LH
	-FRUAPA1283-4	37 SPL camshaft long RH

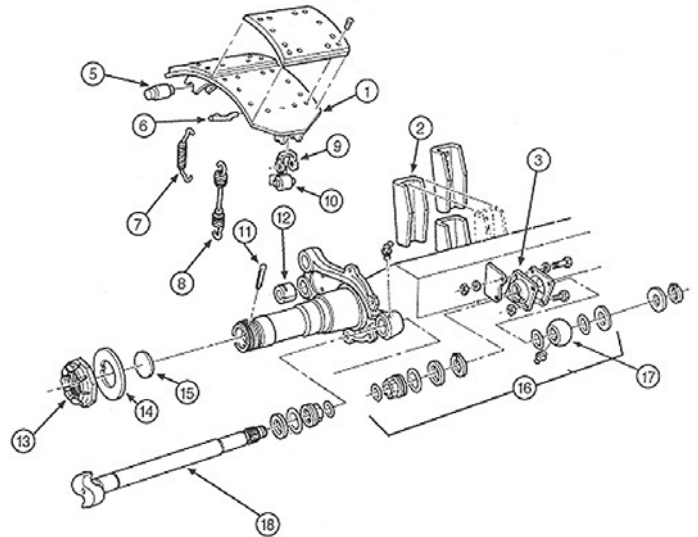

PRO-PAR 5" Square Axle with Brakes
HM518445/HM518410 bearing combination
 for reference only

• BRAKE SHOES •
16.5" × 7" NEW LINED

1 LINED SHOE		
Shoe	Lining	Part Number
4515 ArvinMeritor "Q"	EC20	CRLBN4515QEC2
	MB21	CRLBN4515Q21
4515 Fruehauf XEM3	EC20	CRLBN4515XEC2
	Abex 685	MTRR717011
4707 ArvinMeritor "Q+"	EC20	CRLBN4707QEC2
	MB21	CRLBN4707Q21
4709 Dana Spice/Eaton "ES"	EC20	CRLBN4709E2EC2



2 LINED SHOES W/ HARDWARE		
Shoe	Lining	Part Number
4515 ArvinMeritor "Q"	EC20	CRLKN4515QEC2
	MB21	CRLKN4515Q21
4515 Fruehauf XEM3	EC20	CRLKN4515XEC2
	MG1	MTRKMG14515F
4707 ArvinMeritor "Q+"	EC20	CRLKN4707QEC2
	MB21	CRLKN4707Q21
4709 Dana Spice/Eaton "ES"	EC20	CRLKN4709E2EC2





• HINGE CLUTCH BRAKE •





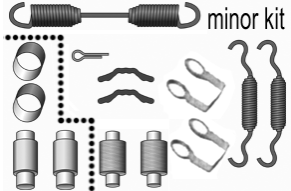
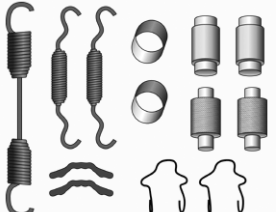
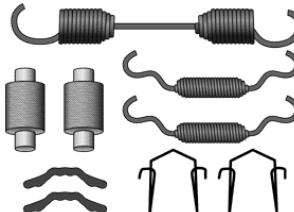
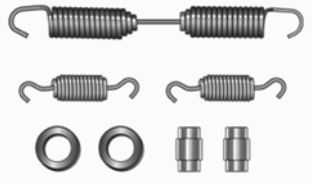
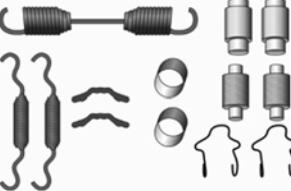
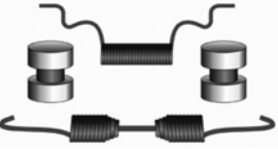
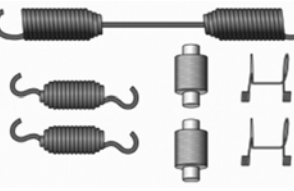
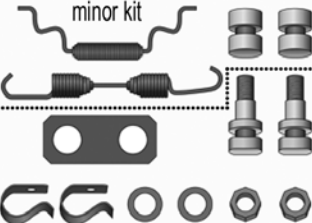
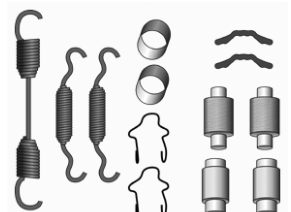
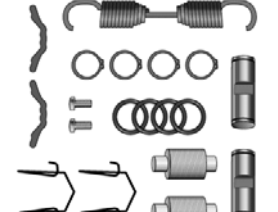
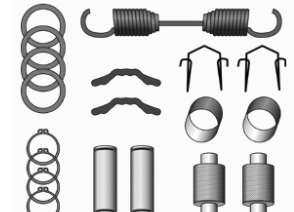

4-1/8" OD 2" Spline Size

MIDBK-313

• BRAKE KITS •

<p>16½" PRO-PAR XEM3</p> 	<p>16½" MERITOR "Q" & "Q+"</p> 	<p>16½" MERITOR "Q" & "Q+"</p> 	<p>16½" EATON</p> 
<p>BRK1-1 BRK1-2 Minor kit</p>	<p>BRK1-7 MTRKIT8000</p>	<p>BRK1-8 SIRQK-2SHD</p>	<p>BRK1-11 SIREK-1HD</p>
<p>16½" MERITOR "Q" & "Q+"</p> 	<p>15" EATON</p> 	<p>16-1/2" EATON "ES"</p> 	<p>15" MERITOR "Q" minor kit</p> 
<p>MTRKIT8000HD HD SIRQK-1HD</p>	<p>SIREF-1</p>	<p>SIRES-1</p>	<p>SIRRF-3 SIRRF-3A Minor kit</p>
<p>15" MERITOR "Q+"</p> 	<p>16½" MERITOR P</p> 	<p>16½" UNIVERSAL REPLACEMENT</p> 	<p>16½" PRO-PAR XEM3</p> 
<p>SIRRF-5</p>	<p>SIRTK-1HD</p>	<p>SIRTK-4HD</p>	<p>SIRXK-3HD</p>

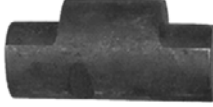
• BRAKE HARDWARE •

<p>Roller</p> 	<p>Roller Retainer</p> 	<p>Anchor Pin</p> 
<p>FRU330733</p>	<p>FRUACD2233-1</p>	<p>FRUACF2668-X 2½" x 7/8"</p>
<p>Q Holddown Spring</p> 	<p>Anchor Pin Washer</p> 	
<p>SIRB220 5½"</p>	<p>WSH2-135 OD=3/8" ID=13/32"</p>	

• **28 SPLINE CAMSHAFTS** •

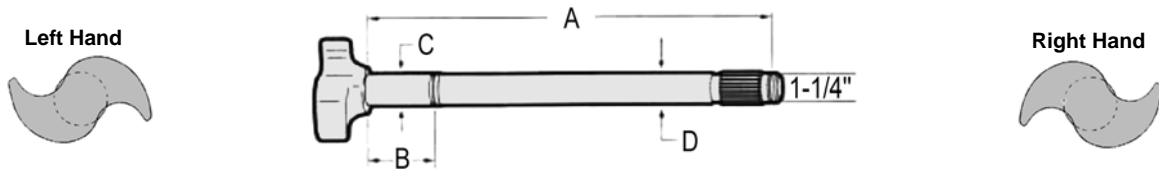

Part Number	Style	Cross			A	B	C	D
DANM16WKL25-175	LH	E9731	L3283	C931L	17-7/16"	2-1/4"	1-5/8"	1 1/2"
DANM16WKL25-205	LH	E9733	L3287	C933L	20-7/16"	2-1/4"	1-5/8"	1 1/2"
DANM16WKR25-205	RH	E9734	L3286	C934R				
DANM16WKL25-242	LH	E10909	L3321	C910L	24-1/16"	2-1/4"	1-5/8"	1 1/2"
DANM16WKR25-242	RH	E10910	L3320	C911R				
HENS-24636-1L	LH	C609L			11-1/16"	2-5/16"	8-11/16"	1 1/2"
HENS-24636-1R	RH	C609R						
MTR2210R8156	LH	E2441	L1299	C441L	17-5/16"	2-5/64"	1-5/8"	1 1/2"
MTR2210Q8155	RH	E2442	L1298	C442R				
SIRC441L	LH	E2441	L1299	2210R8156	17-5/16"	2-5/64"	1-5/8"	1 1/2"
SIRC442R	RH	E2442	L1298	2210Q8155				
SIRC445L	LH	E2445	L1658	2210P4332	24-1/16"	2-5/64"	1-5/8"	1 1/2"
SIRC446R	RH	E2446	L1657	2210N4330				
SIRC935L	LH	E9735	L3289	R607231	23-9/16"	2-1/4"	1-5/8"	1 1/2"
SIRC936R	RH	E9736	L3288	R607232				

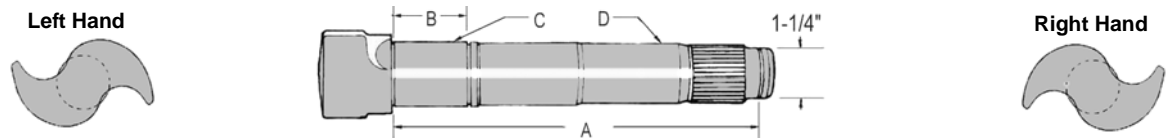

Part Number	Style	Replaces	A	B	C	D
MTR2210B6866	RH	Q+	17-3/8"	1 1/2"	1.62"	1 1/2"
MTR2210C6867	LH	Q+				
MTR2210D6868	RH	Q+	24-9/16"	1 1/2"	1.62"	1 1/2"
MTR2210E6869	LH	Q+				

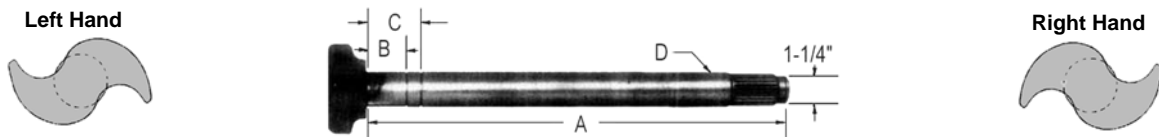

Part Number	Style	Replaces	A	B	C	D
SIRC526L	LH	M16WKL20-23R	23-3/4"	1-5/8"	2-7/32"	1 1/2"
SIRC527R	RH	M16WKR20-23L				

• 37 SPLINE CAMSHAFTS •

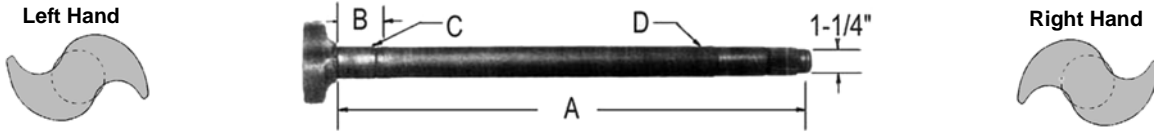

Part Number	Style	Replaces	A	B	C	D
SIRC445L	LH	2210-X-6576 E6081	24-1/8"	2-5/64"	1-5/8"	1 1/2"

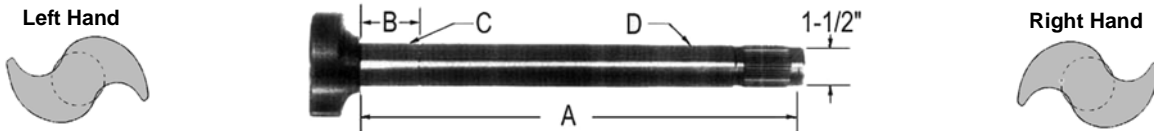

Part Number	Style	Replaces	A	B	C	D
FRUACD2193-PK5	RH	E4891	21-3/16"	2-5/32"	1-5/8"	1-19/32"
FRUACD2193-PK6	LH	E4890				
SIRC100R	RH	E2100 AXA0420-4	21-1/8"	2-5/32"	1-5/8"	1-19/32"
SIRC101L	LH	E2099 AXA0420-3				
SIRC564R	RH	E1564 AXA0420-2	16-1/8"	2-5/32"	1-5/8"	1-19/32"
SIRC563L	LH	E1563 AXA0420-1				

• **CAM KITS** •

DANA



DAN43-7118

DANA



DANM16KY202

PRO-PAR 12-1/4" & 16 1/2"

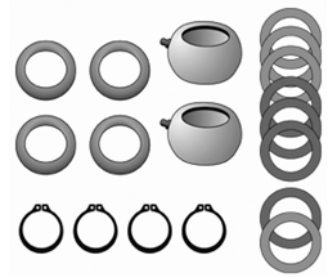

FRUAXA0420-900
SIRB8649

HENDRICKSON Intraxx®

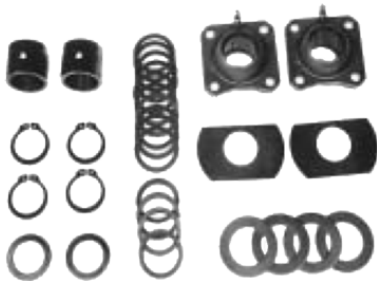

HENS-21181

HENDRICKSON Intraxx® ES Major Overhaul Kit



HENS-23974

MERITOR 4000-6000 trailer axle



MTRKIT8048
SIRB8683

MERITOR "Q" Axles



MTRKIT8069

MERITOR "Q" & "Q+" Trailer Axles



MTRKIT8078 One axle
SIRB8773M Two axle

MERITOR "Q" & "Q+" Trailer Axles Minor Kit

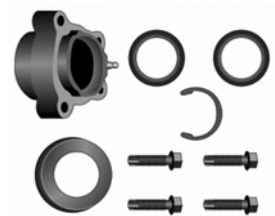

MTRKIT8289
SIRB8788

MERITOR 4000-6000 Trailer Axle w/o Bracket



MTRKIT970
SIRB8645

DANA 16 1/2"

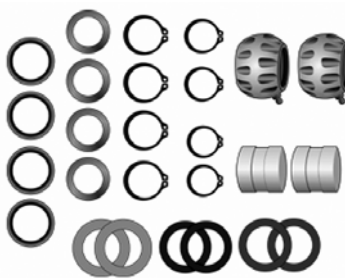

SIRB8652

STANDARD FORGE (DANA) weld-on spider

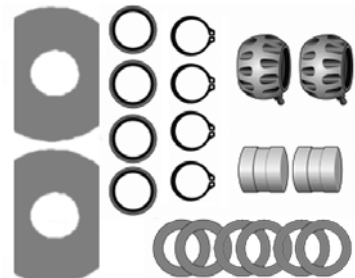

SIRB8653

SPICER & STANDARD FORGE Late Model Axles

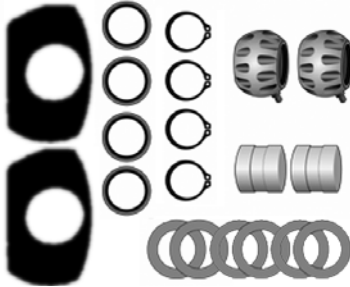

SIRB8655

EATON 5" Axle



SIRB8657

MERITOR P Trailer Brake w/ 1 1/2" dia. Cams



SIRB8681

EATON "501" Series & ES brakes



SIRB8684

SPICER 12-1/4" brake w/ 1-5/8" Camshaft

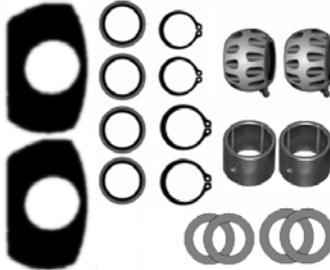

SIRB8792

• CAMSHAFT BRACKETS •



FRUAXA0430-1 A = 21/32"
B = 2-7/8" Primed



FRUACF4021-1



FRUACF9462-1 w/Zerk fitting



FRUACF4024-1 For 16½" brakes



MTRA-3299T5844



SIRB8696

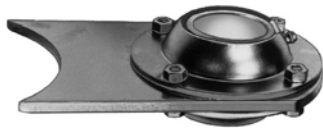

SIRB8714

• CAMSHAFT BUSHINGS •



FRUACD2285-900



FRUAXA0429-900



MTRR657003



SIRB8606

• CAMSHAFT ACCESSORIES •

Bearing Washer



FRUAXA0417-1 OD 2-3/8"
ID 1-41/64
FRUAXA0432-1 OD 2-3/8"
ID 1-33/64"

Camshaft Seal



SIRB8612A OD 1-7/8" ID 1½"





Retainer Ring



FRU219160 ID 1-3/8"
FRUAXA0418-1 ID 1-7/8"

• **MANUAL SLACK ADJUSTERS** •

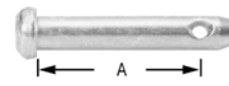



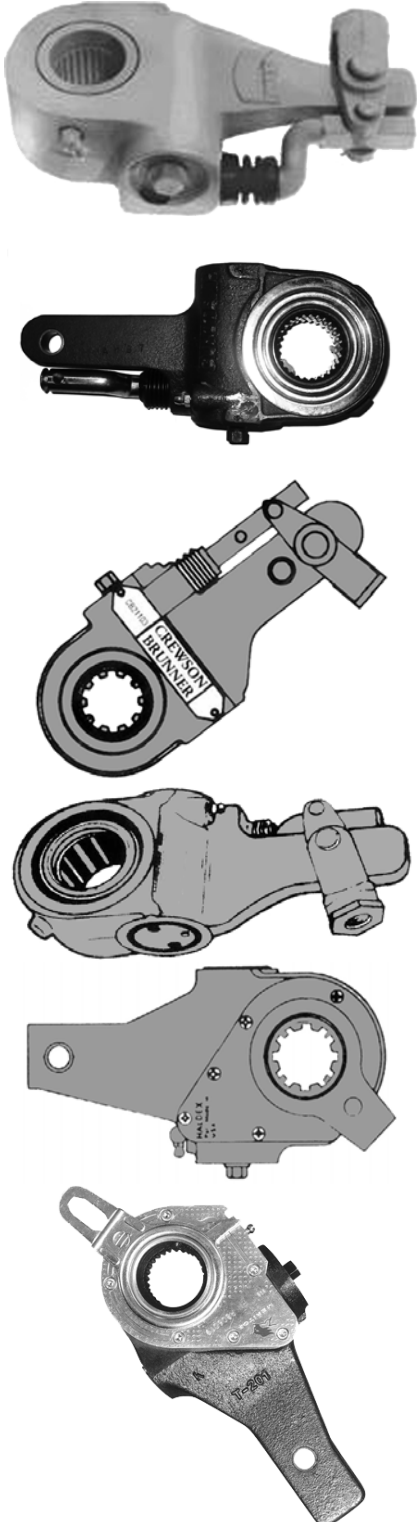

Spline	Part Number	Arm Length	
1 1/2" 10	BEN278323	5", 6", 7"	
	FRUACF6404-903		
	SIRS2010A		
	BEN278326	5.5", 6.5"	
	FRUACF6404-906		
1 1/2" 28	MIDKN44051	5", 6"	
	BEN286965	5", 6", 7"	
	FRUACF6404-902		
	SIRS2022A		
	BEN288753	5.5", 6.5"	
	FRUACF6404-905		
1-5/8" 37	BEN283411	6"	
	FRUACF6404-1		
	SIRS2012A		
	FRUACF6404-4	5.5"	
	FRUACF6404-901	5", 6", 7"	

		
ANC9999044 A = 1/2" Clevis kit MIDKN36470 A = 1/2" Clevis kit MIDKN36480 A = 5/8" Clevis kit	MID19102 5/8" Clevis & cotter pin	MTR19X1084 A = 1-7/8" dia. = 1/2" MTR19X127 A = 1-37/64" dia. = 1/4"
		
MID19100 1/2" Clevis pin MID19102 5/8" Clevis pin	PIN1-1 2" x 1" Cotter pin	

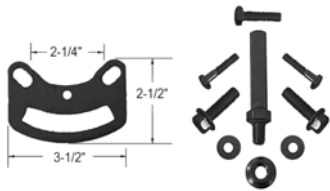
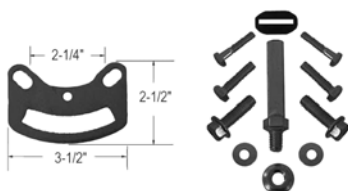









• AUTOMATIC SLACK ADJUSTERS •

Spline	Part Number	Arm Length	
1-1/2" 10	BRUCB21103	5", 6"	
	HDX400-10142		
	MTRR806022		
	MTRR801041	5.5"	
	BRUCB21102	5.5", 6.5"	
	HDX400-10143		
	BRUCB41106	6"	
	HDX400-10144		
	HDX400-10216		
	HDX400-10306		
MTRR801042			
1-1/2" 28	BRUCB22103	5", 6"	
	BEN065174	5.5"	
	BEN065247		
	BRUCB42100		
	HDX400-10156		
	HDX400-10211		
	HDX400-10304		
	HDX400-20211		
	MTRR801073		
	MTRR801079		
	MTRR802447		
	MTRR806019		
	BRUCB22102	5.5", 6"	
	HDX400-10141	5.5", 6.5"	
	BEN065176	6"	
	GUNASA02201		
	HDX400-10140		
	HDX400-10212		
	HDX400-10305		
	MTRR801074		
MTRR802446			
MTRR806013			
1-5/8" 37	FRUACF8184-2	5.5"	
	HDX400-10213		
	MTRR801101		
	BRUCB23102	5.5", 6.5"	
	BEN283411	6"	
	BRUCB23106		
	FRUACF8184-1		
	HDX400-10214		
MTRR801102			

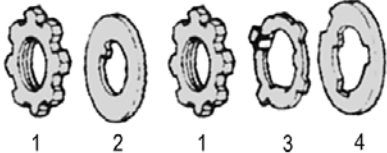
• AUTOMATIC SLACK ADJUSTERS ACCESSORIES •

		
<p>HDX427-10563 Bracket kit</p>	<p>HDX427-10565 Bracket kit</p>	<p>HDX427-10558 Stud kit</p>
		
<p>HDX452-10125 Control arm bushing</p>	<p>MID19102 5/8" Clevis & cotter pin MID19100 1/2" Clevis pin MTRR801773 1/2" Clevis pin PIN1-1 .12" x 1" Cotter pin</p>	<p>MTRR801700 Guide pawl adjuster</p>
		
<p>MTRR801713 5/8" Clevis</p>		

• AXLE NUTS & ACCESSORIES •

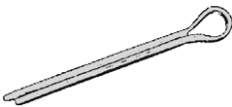
<p>HM218248/HM218210 inner HM212049/HM212011 outer</p> 	<p>HM218248/HM218210 inner HM212049/HM212011 outer</p> 	<p>HM218248/HM218210 inner HM212049/HM212011 outer</p> 
<p>MTRKITSTNEW 1 Axle kit</p>	<p>SIR5200 3/8" Outer nut</p>	<p>MTRR000540 3/8" Inner nut SIR5210</p>
<p>HM218248/HM218210 inner HM212049/HM212011 outer</p> 	<p>HM518445/518410</p> 	<p>HM518445/HM518410</p> 
<p>SIR5300 Washer MTRR000573 Washer</p>	<p>FRUACF1823-900 HD kit 1. FRUACF1823-1 Stamped axle nut 2. FRUAXA0408-1 Washer 3. FRUACF1821-1 Lockwasher 4. FRUACF1822-1 Washer</p>	<p>MTRKITSTPN 1/2 Axle kit</p>
<p>HM518445/HM518410</p> 	<p>HM518445/HM518410</p> 	<p>HM518445/HM518410</p> 
<p>MTR1227K1389 3/4" Outer nut</p>	<p>FRUACE8510-1 HD Outer nut MTR1227D1226 HD Outer nut</p>	<p>MTR1227B1484 3/8" Inner nut</p>
<p>HM518445/HM518410</p> 	<p>HM518445/HM518410</p> 	
<p>EAT814856 Washer</p>	<p>MTR1229Z3068 Washer</p>	<p>FRUAXA0409-PK1 Cotter pin</p>

PRO-TORQUE			
Part Number	Size	Application	Bearing Combination
STE447-4723	3.48"—12	Pro-Par, Meritor TP Hendrickson HP	HM518445/HM518410
STE447-4743	2-5/8"—16	Dana, Eaton, Meritor RL, RQ, TK, TN, TQ Hendrickson HN	HM212049/HM212011
STE449-4973	3-1/4"—12	Dana Est-230-P Eaton -22 Meritor TR	580/572



• **AXLE DUST SHIELDS** •



FRUAPA1192-3



HENS-23579-2

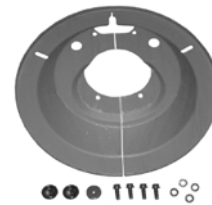

AXL41708060
MTRR009095

• **AIR CHAMBER MOUNTING BRACKETS** •

5" Round Axle



FRUACE7260-1 2 Hole

5" Square Axles



FRUACF6608-1 2 Hole
FRUACF6608-2 1 Hole



DANM10WJ227



MTR3299A5981

• **AXLE ACCESSORIES** •

Pro-Par Socket Wrench



FRUACC5963-900

Freeze Plug



FRUACD7180-1

5" Round Spring Chair

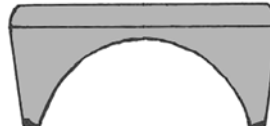

FRUACF8391-1

5" Square Spring Chair



FRUAXA0512-1

• **AXLE ALIGNMENT TOOLS** •

Bazooka Tool



SWE165

Axle Extender



SWE161-9

Level Gauge



SWE165-7