

Manual TP-0445

Parts Failure Analysis

Supersedes Manual TP-87123

Revised 04-08

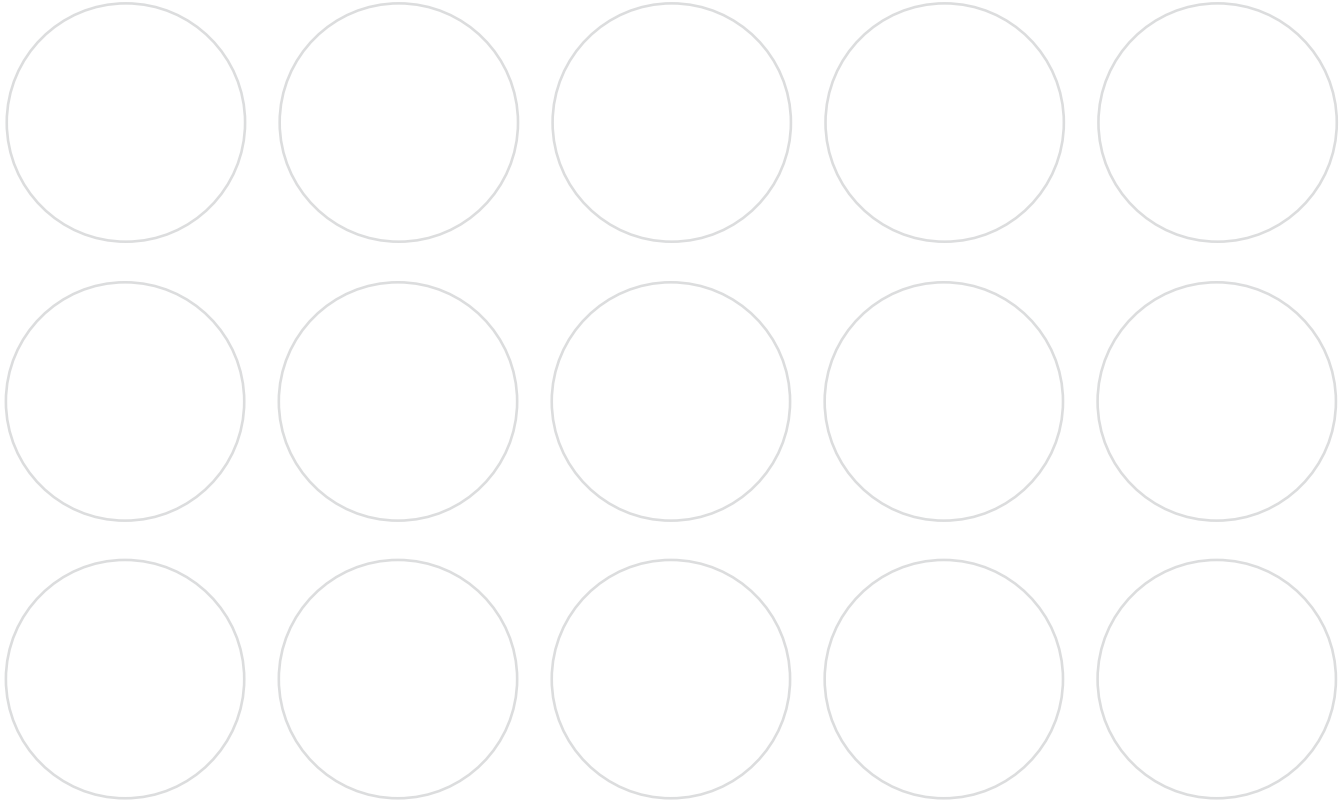

Service Notes

About This Publication

This publication provides a parts analysis process to help you determine why parts failed during operation, what to look for when you inspect parts, and how to help prevent failures from occurring again.

Section 1 is an overview of parts analysis, and Section 2 provides guidelines for using an investigative approach during the analysis process.

Section 3 contains descriptions of failure types that affect parts, as well as parts analysis terminology that's used in the field to describe conditions that cause components to fail.

Section 4, Section 5, Section 6, Section 7, Section 8, Section 9 and Section 10 include parts analysis information for the following components.

- Automatic Slack Adjusters
- Brakes
- Drive Axles
- Drivelines
- Trailer Axles
- Transmissions
- Transfer Cases

How to Obtain Additional Maintenance and Service Information

On the Web

Visit Literature on Demand at arvinmeritor.com to access and order product, service, aftermarket, and warranty literature for ArvinMeritor's truck, trailer and specialty vehicle components.

Literature on Demand DVD (LODonDVD)

The LODonDVD contains product, service and warranty information for ArvinMeritor components. To order the DVD, visit Literature on Demand at arvinmeritor.com and specify TP-0742.

Information contained in this publication was in effect at the time the publication was approved for printing and is subject to change without notice or liability. Meritor Heavy Vehicle Systems, LLC, reserves the right to revise the information presented or to discontinue the production of parts described at any time.

pg. i	Asbestos and Non-Asbestos Fibers	pg. 12	Normal Wear
1	Section 1: Introduction to Parts Analysis		Offset Frosting
	Parts Analysis Overview		Origin Point
	Types of Wear		Pitting (Surface Fatigue)
	Main Causes of Premature Wear and Component Failure	13	Premature Wear
4	Section 2: An Investigative Approach		Ratchet Marks
	Guidelines to an Investigative Approach		Reverse Bending Fatigue (Fatigue Fracture)
	Record Your Findings	14	Root Beam Fatigue (Fatigue Fracture)
	Ask Questions		Scoring
	Preparing Parts for Inspection		Scuffing (Galling)
	How to Prepare Damaged Parts for Inspection		Shock Load (Impact Fracture)
	Inspection Procedures for Parts Analysis	16	Spalling (Surface Fatigue)
	Inspect Damaged Parts		Spinout
5	Section 3: Failure Types and Terminology		Stress Riser
	Parts Analysis	17	Surface (Contact) Fatigue
	Beach Marks		Torque
	Bending Fatigue (Fatigue Fracture)	18	Torsional Fatigue (Fatigue Fracture)
6	Black Spots		Torsional Vibration
	“Blue” Brake Drum		Witness Marks
	Brinelling (Surface Fatigue)		Working Angle
7	Burnish (Brakes)	19 Section 4: Drive Axles	Parts Analysis Overview
	Bruising (Surface Fatigue)		Common Causes of Drive Axle Component Failures
	Chevron Wear Pattern	20	A Vehicle is Operated Outside its Application or Vocation
	Brake Compounding		Exceeding an Axle’s Maximum Gross Axle Weight Rating (GAWR)
	Crack-Pressure		Axle Fatigue
	Crow’s Footing (Surface Fatigue)	23	Spinout
8	Crystalline Wear Pattern		Examples of Typical Spinout Damage
	“Drive” and “Coast” Sides of Hypoid Ring Gear Teeth	25	Shock Load
	Etching (Surface Fatigue)	27	Unapproved Vehicle or Powertrain Modifications
9	Extreme Pressure (EP) Additives		The Vehicle Isn’t Maintained According to Meritor’s Recommended Maintenance Practices
	Flank Cracking (Surface Fatigue)		The Lubricant is Incorrect
	Fatigue Fracture	29	Contaminated Lubricant
10	Fretting (Surface Fatigue)		Low Lubricant Levels
	Frosting	30	Metal Particles on the Magnetic Fill/Drain Plug
	Galling (Surface Fatigue)		Remove and Inspect the Magnetic Fill/Drain Plug Guidelines
11	Gear Ratio and Torque Multiplication	31	Check the Condition of the Oil
	Heat Checking		Oil Conditions
	Hot Spotting (Black Spots)	32	Components Overheat During Operation
	Imbalance (Brake)		Parts Analysis Process
	Impact Fracture		Bearing Adjusting Ring
	Load Cycle	34	Drive Pinion Gear
	Gross Axle Weight Rating (GAWR)	35	Driver-Controlled Main Differential Lock (DCDL) Shift Collar
	Gross Vehicle Weight Rating (GVWR)	36	Flange-Side Main Differential Bearing
	Gross Vehicle Weight (GVW)	37	Axle Housings
12	Gross Combined Weight Rating (GCWR)	38	Hypoid Ring and Drive Pinion Gears
	Gross Combined Weight (GCW)		Inner Drive Pinion Bearing
	Mismatched Tires (Drive Axle)		
	Mismatched Tandem Axle Ratios		

Contents

pg. 40	Inter-Axle Differential (IAD)	pg. 70	Heat Checking
43	Main Differential	71	Heat Checking on Only One Side of the Drum
44	Flange-Side Main Differential Pinion Nut		Conditions That Can Cause Failures to Occur
45	Plain-Half Differential Case		Black Spots (Hot Spotting) on the Drum's Surface
46	Main Differential Case-to-Case Joint Separation Pump System Screens	72	Polished (Glazed) Drum
47	Rear Side Gear		Scoring
48	Ring Gear	73	"Blue" Drum
50	Side Gears Axle Shaft and Differential Side Gear Spline Side Gear Thrust Washer		Broken Bolt Flange (Drum Surface Not Cracked)
51	Thrust Washers Oil Seals		Broken Bolt Flange (Cracked Drum Surface)
52	Seal Test Procedure Example 1: The Seal is not Leaking	74	Cracked Drum
53	Example 2: The Seal Appears to be Leaking Example 3: The Seal is Leaking		Worn Brake Drum Bolt Holes
55	Section 5: Drivelines Parts Analysis Overview Evaluate Damaged Driveline Components Driveline Components U-Joint	75	Oil or Grease Has Penetrated and Discolored the Drum Surface
56	Drive Shaft Tube Yokes	76	Conditions That Can Affect Brake Drum Wear
57	U-Joint Trunnion	77	Section 9: Transmissions
58	Splined Shaft		Parts Analysis Overview
59	Section 6: Trailer Axles Parts Analysis Overview Evaluate Damaged Trailer Axle Components Main Causes of Trailer Axle Failure Trailer Axle		Evaluate Damaged Transmission Components
62	Section 7: Automatic Slack Adjusters Parts Analysis Overview Evaluate Damaged Automatic Slack Adjusters Automatic Slack Adjuster Pawl Teeth		Causes of Transmission Failures
63	Automatic Slack Adjuster Automatic Slack Adjuster and Camshaft Splines		Parts Analysis Process
64	Section 8: Cam and Air Disc Brakes Parts Analysis Overview Evaluate Damaged Brake Components Main Causes of Cam and Air Disc Brake Component Failures Cam and Air Disc Brakes	81	Spur Gears
68	Air Disc Brakes Only	84	Roller Bearings
69	Model ADB 1560 Air Disc Brake Only Brake Drums	85	Main Shaft Washer
		87	Main Shaft Gear Float Clearance
		90	Gear Teeth
		91	Synchronizer Pin
		92	Shift Collar Wear
			Oil Seals
			Seal Test Procedure
			Example 1: The Seal is Not Leaking
			Example 2: The Seal Appears to be Leaking
		93	Example 3: The Seal Appears to be Leaking
			Example 4: The Seal is Leaking
		94	Troubleshooting and Diagnostics
			Types of Problems
		95	Troubleshooting Other Systems
		96	Troubleshooting Leaks
		97	Troubleshooting Vibrations
		98	Troubleshooting Noises
		99	Troubleshooting Operating Conditions
		102	Range Shift System Diagnostics for Platform G Transmissions
		106	Section 10: Transfer Cases
			Parts Analysis Overview
			Evaluate Damaged Transfer Case
			Front Idler Bearing
		107	Front Output Shaft

ASBESTOS FIBERS WARNING

The following procedures for servicing brakes are recommended to reduce exposure to asbestos fiber dust, a cancer and lung disease hazard. Material Safety Data Sheets are available from ArvinMeritor.

Hazard Summary

Because some brake linings contain asbestos, workers who service brakes must understand the potential hazards of asbestos and precautions for reducing risks. Exposure to airborne asbestos dust can cause serious and possibly fatal diseases, including asbestosis (a chronic lung disease) and cancer, principally lung cancer and mesothelioma (a cancer of the lining of the chest or abdominal cavities). Some studies show that the risk of lung cancer among persons who smoke and who are exposed to asbestos is much greater than the risk for non-smokers. Symptoms of these diseases may not become apparent for 15, 20 or more years after the first exposure to asbestos.

Accordingly, workers must use caution to avoid creating and breathing dust when servicing brakes. Specific recommended work practices for reducing exposure to asbestos dust follow. Consult your employer for more details.

Recommended Work Practices

1. **Separate Work Areas.** Whenever feasible, service brakes in a separate area away from other operations to reduce risks to unprotected persons. OSHA has set a maximum allowable level of exposure for asbestos of 0.1 f/cc as an 8-hour time-weighted average and 1.0 f/cc averaged over a 30-minute period. Scientists disagree, however, to what extent adherence to the maximum allowable exposure levels will eliminate the risk of disease that can result from inhaling asbestos dust. OSHA requires that the following sign be posted at the entrance to areas where exposures exceed either of the maximum allowable levels:

DANGER: ASBESTOS
CANCER AND LUNG DISEASE HAZARD
AUTHORIZED PERSONNEL ONLY
RESPIRATORS AND PROTECTIVE CLOTHING
ARE REQUIRED IN THIS AREA.

2. **Respiratory Protection.** Wear a respirator equipped with a high-efficiency (HEPA) filter approved by NIOSH or MSHA for use with asbestos at all times when servicing brakes, beginning with the removal of the wheels.

3. **Procedures for Servicing Brakes.**

a. Enclose the brake assembly within a negative pressure enclosure. The enclosure should be equipped with a HEPA vacuum and worker arm sleeves. With the enclosure in place, use the HEPA vacuum to loosen and vacuum residue from the brake parts.

b. As an alternative procedure, use a catch basin with water and a biodegradable, non-phosphate, water-based detergent to wash the brake drum or rotor and other brake parts. The solution should be applied with low pressure to prevent dust from becoming airborne. Allow the solution to flow between the brake drum and the brake support or the brake rotor and caliper. The wheel hub and brake assembly components should be thoroughly wetted to suppress dust before the brake shoes or brake pads are removed. Wipe the brake parts clean with a cloth.

c. If an enclosed vacuum system or brake washing equipment is not available, employers may adopt their own written procedures for servicing brakes, provided that the exposure levels associated with the employer's procedures do not exceed the levels associated with the enclosed vacuum system or brake washing equipment. Consult OSHA regulations for more details.

d. Wear a respirator equipped with a HEPA filter approved by NIOSH or MSHA for use with asbestos when grinding or machining brake linings. In addition, do such work in an area with a local exhaust ventilation system equipped with a HEPA filter.

e. **NEVER** use compressed air by itself, dry brushing, or a vacuum not equipped with a HEPA filter when cleaning brake parts or assemblies. **NEVER** use carcinogenic solvents, flammable solvents, or solvents that can damage brake components as wetting agents.

4. **Cleaning Work Areas.** Clean work areas with a vacuum equipped with a HEPA filter or by wet wiping. **NEVER** use compressed air or dry sweeping to clean work areas. When you empty vacuum cleaners and handle used rags, wear a respirator equipped with a HEPA filter approved by NIOSH or MSHA for use with asbestos. When you replace a HEPA filter, wet the filter with a fine mist of water and dispose of the used filter with care.

5. **Worker Clean-Up.** After servicing brakes, wash your hands before you eat, drink or smoke. Shower after work. Do not wear work clothes home. Use a vacuum equipped with a HEPA filter to vacuum work clothes after they are worn. Launder them separately. Do not shake or use compressed air to remove dust from work clothes.

6. **Waste Disposal.** Dispose of discarded linings, used rags, cloths and HEPA filters with care, such as in sealed plastic bags. Consult applicable EPA, state and local regulations on waste disposal.

Regulatory Guidance

References to OSHA, NIOSH, MSHA, and EPA, which are regulatory agencies in the United States, are made to provide further guidance to employers and workers employed within the United States. Employers and workers employed outside of the United States should consult the regulations that apply to them for further guidance.

NON-ASBESTOS FIBERS WARNING

The following procedures for servicing brakes are recommended to reduce exposure to non-asbestos fiber dust, a cancer and lung disease hazard. Material Safety Data Sheets are available from ArvinMeritor.

Hazard Summary

Most recently manufactured brake linings do not contain asbestos fibers. These brake linings may contain one or more of a variety of ingredients, including glass fibers, mineral wool, aramid fibers, ceramic fibers and silica that can present health risks if inhaled. Scientists disagree on the extent of the risks from exposure to these substances. Nonetheless, exposure to silica dust can cause silicosis, a non-cancerous lung disease. Silicosis gradually reduces lung capacity and efficiency and can result in serious breathing difficulty. Some scientists believe other types of non-asbestos fibers, when inhaled, can cause similar diseases of the lung. In addition, silica dust and ceramic fiber dust are known to the State of California to cause lung cancer. U.S. and international agencies have also determined that dust from mineral wool, ceramic fibers and silica are potential causes of cancer.

Accordingly, workers must use caution to avoid creating and breathing dust when servicing brakes. Specific recommended work practices for reducing exposure to non-asbestos dust follow. Consult your employer for more details.

Recommended Work Practices

1. **Separate Work Areas.** Whenever feasible, service brakes in a separate area away from other operations to reduce risks to unprotected persons.

2. **Respiratory Protection.** OSHA has set a maximum allowable level of exposure for silica of 0.1 mg/m³ as an 8-hour time-weighted average. Some manufacturers of non-asbestos brake linings recommend that exposures to other ingredients found in non-asbestos brake linings be kept below 1.0 f/cc as an 8-hour time-weighted average. Scientists disagree, however, to what extent adherence to these maximum allowable exposure levels will eliminate the risk of disease that can result from inhaling non-asbestos dust.

Therefore, wear respiratory protection at all times during brake servicing, beginning with the removal of the wheels. Wear a respirator equipped with a high-efficiency (HEPA) filter approved by NIOSH or MSHA, if the exposure levels may exceed OSHA or manufacturers' recommended maximum levels. Even when exposures are expected to be within the maximum allowable levels, wearing such a respirator at all times during brake servicing will help minimize exposure.

3. **Procedures for Servicing Brakes.**

a. Enclose the brake assembly within a negative pressure enclosure. The enclosure should be equipped with a HEPA vacuum and worker arm sleeves. With the enclosure in place, use the HEPA vacuum to loosen and vacuum residue from the brake parts.

b. As an alternative procedure, use a catch basin with water and a biodegradable, non-phosphate, water-based detergent to wash the brake drum or rotor and other brake parts. The solution should be applied with low pressure to prevent dust from becoming airborne. Allow the solution to flow between the brake drum and the brake support or the brake rotor and caliper. The wheel hub and brake assembly components should be thoroughly wetted to suppress dust before the brake shoes or brake pads are removed. Wipe the brake parts clean with a cloth.

c. If an enclosed vacuum system or brake washing equipment is not available, carefully clean the brake parts in the open air. Wet the parts with a solution applied with a pump-spray bottle that creates a fine mist. Use a solution containing water, and, if available, a biodegradable, non-phosphate, water-based detergent. The wheel hub and brake assembly components should be thoroughly wetted to suppress dust before the brake shoes or brake pads are removed. Wipe the brake parts clean with a cloth.

d. Wear a respirator equipped with a HEPA filter approved by NIOSH or MSHA when grinding or machining brake linings. In addition, do such work in an area with a local exhaust ventilation system equipped with a HEPA filter.

e. **NEVER** use compressed air by itself, dry brushing, or a vacuum not equipped with a HEPA filter when cleaning brake parts or assemblies. **NEVER** use carcinogenic solvents, flammable solvents, or solvents that can damage brake components as wetting agents.

4. **Cleaning Work Areas.** Clean work areas with a vacuum equipped with a HEPA filter or by wet wiping. **NEVER** use compressed air or dry sweeping to clean work areas. When you empty vacuum cleaners and handle used rags, wear a respirator equipped with a HEPA filter approved by NIOSH or MSHA, to minimize exposure. When you replace a HEPA filter, wet the filter with a fine mist of water and dispose of the used filter with care.

5. **Worker Clean-Up.** After servicing brakes, wash your hands before you eat, drink or smoke. Shower after work. Do not wear work clothes home. Use a vacuum equipped with a HEPA filter to vacuum work clothes after they are worn. Launder them separately. Do not shake or use compressed air to remove dust from work clothes.

6. **Waste Disposal.** Dispose of discarded linings, used rags, cloths and HEPA filters with care, such as in sealed plastic bags. Consult applicable EPA, state and local regulations on waste disposal.

Regulatory Guidance

References to OSHA, NIOSH, MSHA, and EPA, which are regulatory agencies in the United States, are made to provide further guidance to employers and workers employed within the United States. Employers and workers employed outside of the United States should consult the regulations that apply to them for further guidance.

Parts Analysis Overview

This publication provides a parts analysis process to help you determine why parts failed during operation, what to look for when you inspect parts, and how to help prevent failures from occurring again. Figure 1.1, Figure 1.2 and Figure 1.3 are examples of failed parts.

Most of the time, you can find the answers you need by visually inspecting a failed component. Sometimes, however, this process may require specialized knowledge or equipment.

Also, why a product failed can be difficult to determine, because a failure can vary in appearance from vehicle to vehicle. Failures in models from the same manufacturer can also vary, so it's important to use the information presented here as a guide, not a rule, when you perform parts analysis inspections.



Figure 1.1



Figure 1.2



Figure 1.3

Types of Wear

Normal Wear

Components that are operated correctly, and inspected and maintained at recommended intervals, will eventually wear under normal operating conditions. This is called “normal” wear.

Premature Wear

Components can wear prematurely and fail when a vehicle is operated under the following conditions.

Main Causes of Premature Wear and Component Failure

A Vehicle is Not Operated Correctly, or is Operated Abusively

When a driver doesn't operate a vehicle correctly, or operates it abusively, components can fail immediately. Often, however, damaged components will continue to operate, but fail at a later time — even under normal operating conditions.

1 Introduction to Parts Analysis

For example, when a driver speeds up the engine and rapidly releases the clutch (“popping the clutch”), or allows a vehicle’s spinning wheel to hit dry pavement, it causes an immediate load, or force, to the driveline. Component failure can occur immediately, or at a later time. Figure 1.4 and Figure 1.5.

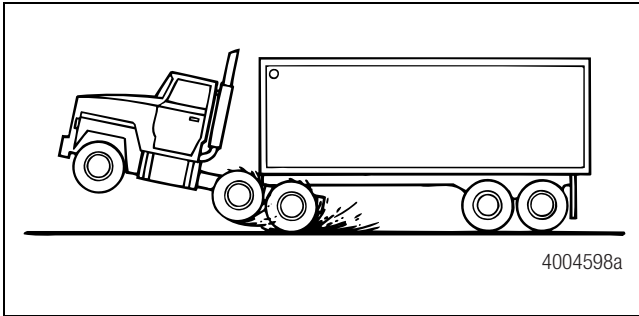

Figure 1.4

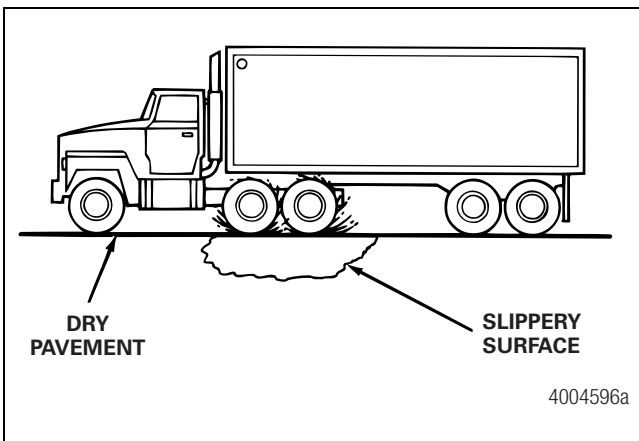

Figure 1.5

A Vehicle is Not Maintained Correctly

Premature wear and damage to components will result if a vehicle is not correctly maintained according to Meritor’s recommended maintenance intervals and lubricant specifications. For example, the lubricant is not specified by Meritor; the lubricant is contaminated; or there’s insufficient lubricant or no lubricant at all in the system.

For example, lubricant contaminated with water, dirt or wear particles will damage the mating surfaces of components, particularly bearing surfaces. Other areas of concern are seals and breathers. Figure 1.6.

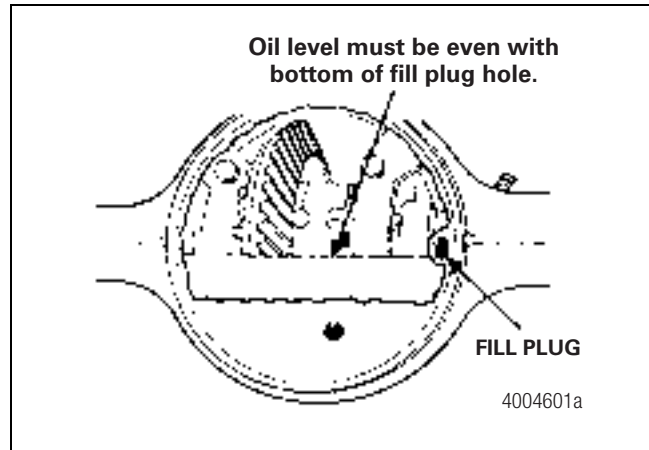

Figure 1.6

A Vehicle is Operated Outside Application, Equipment and Load Limits Approved by Meritor

Components must be operated within the application guidelines specified by Meritor. Otherwise, Meritor must approve applications for vehicles operated outside these guidelines.

Meritor has four application types: linehaul, general service, heavy service and restricted service. The descriptions in the table below are typical for these types.

1 Introduction to Parts Analysis

Table A

Application	Miles Per Year	Operating Conditions
Linehaul	Over 60,000	A vehicle operates on concrete, asphalt, maintained gravel, crushed rock, hard-packed dirt or other similar surfaces (moderate grades) and averages two stops and starts per mile.
General Service	Less than 60,000	A vehicle operates mostly on-road (less than 10% off-road) and averages two stops and starts per mile.
Heavy Service	Less than 60,000	A vehicle operates both on- and off-road (10% or more off-road) with moderate-to-frequent stops and starts that average up to 10 stops per mile.
Restricted Service	Low mileage	Usually these vehicles are not licensed for highway use, are restricted to 15 mph, and average six stops and starts per mile.

2 An Investigative Approach

Guidelines to an Investigative Approach

When you visually inspect damaged components, a common error you can make is to assume the first damaged component you find is likely responsible for the failure. However, it's important to remember that instead of being the *cause* of the failure, the damaged component actually may be the *result* of the failure.

A positive way to conduct a failure analysis inspection is to use an investigative approach. Here are guidelines that will help you to perform a failure analysis inspection.

Record Your Findings

Before you begin, be prepared to record all the results you obtain from asking questions, and observing and inspecting damaged parts.

Ask Questions

Try to Speak to People Who Can Help with Your Investigation

Try to speak to the vehicle's operator, the driver who recovered the vehicle, and the repair technician. If an accident occurred, try to talk to those people knowledgeable about the circumstances. A person who's witnessed the failure can provide important information, but it's important to listen objectively to all reports.

About Damaged Parts

Did components fail over time or instantaneously? Were components stressed by cyclic overload?

What component or part failed first? Was the failure a result of a vehicle system failure? What's the torque rating of the component that failed?

Was the component repaired recently? Can you speak to the technician who repaired the component?

Verify the weather and road conditions at the time of the failure. Was the vehicle involved in an accident? If so, can you see the accident report or talk to witnesses?

About the Vehicle

Determine if the vehicle was towed or driven to a garage for repair. Was it connected to a trailer, or had the vehicle just been connected to a trailer?

What's the vehicle's in-service date and application type?

Verify the vehicle's application and length of service. Check the vehicle's mileage.

What were the vehicle's static and dynamic loading conditions? Is there evidence of cyclic loading or torsional vibration?

Was the vehicle maintained correctly? Check the vehicle's service and maintenance logs, as well as the types and brands of grease and oil used. Are the lubricants the correct specification approved by Meritor?

Check the vehicle's overall condition. Look for grease and oil leaks. Look for signs of abuse and recent repair. Check tire wear. Where possible, remove inspection plates, access doors and top covers to find potential component damage in these areas.

Is the vehicle covered with mud? Does it look as if it's recently been powerwashed? If so, the vehicle may have been operated in an application that wasn't approved by Meritor.

Is the vehicle equipped with a lift axle, and was it in use at the time of the failure? Does the vehicle have multiple retarders?

Preparing Parts for Inspection

How to Prepare Damaged Parts for Inspection

Don't clean parts before you inspect them. Parts should be left in their failed condition and position. If possible, the parts should remain with the vehicle; and if outdoors, protected from rain, contaminants, sand, etc.

Inspection Procedures for Parts Analysis

Inspect Damaged Parts

Collect the damaged parts. This includes Meritor components, as well as those from other manufacturers. Assemble components into their original working order.

If there's only one failure point or damaged component, begin the inspection there. If there's more than one, inspect each component individually.

Inspect the areas around components. Try to determine the failure type. Was it surface or fatigue fracture? Shock load? Was the failure caused by insufficient lubrication or an incorrect lubricant? Was the failure caused by spinout?

Thoroughly inspect components for witness marks that can give clues to why a component failed. Check for signs of vehicle abuse.

When you're inspecting a gear box that's still assembled, check the end play, backlash, tooth contact pattern, runout, etc.

3 Failure Types and Terminology

Parts Analysis

This section provides descriptions of part failure types, as well as parts analysis terminology that's used in the field to describe conditions that cause components to fail.

Beach Marks

Beach marks result from a fatigue fracture and indicate the progressive positions of an advancing fracture. Beach marks appear as irregular curved rings that radiate from one or more origins. They're typically found on fractures caused by periodic or prolonged stress from load applications.

Beach marks represent fatigue cycles that occurred before the component failed completely. Visually, beach marks are often compared to the rippling effect of a stone thrown into calm water. Figure 3.1.

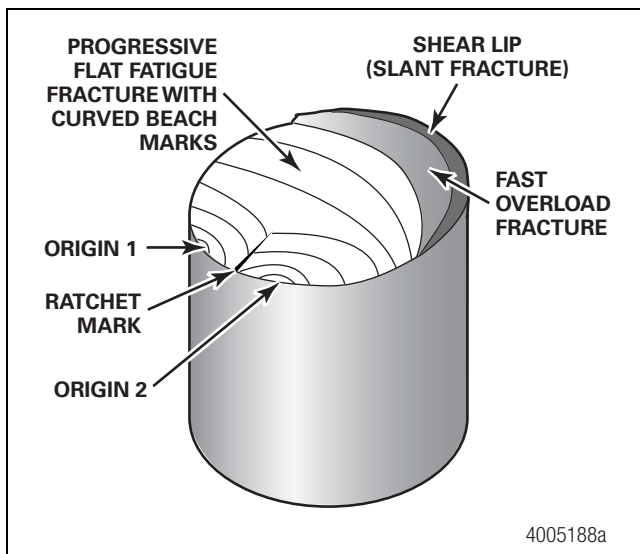

Figure 3.1

Bending Fatigue (Fatigue Fracture)

Bending is a type of fatigue fracture that occurs when a shaft is subjected to both torsional and bending fatigue at the same time. Beach marks form and usually point toward the origin of the fracture, which represents fatigue fracture cycles that occurred before the component failed completely. Figure 3.2 shows beach marks on an axle shaft that indicate it fractured as a result of bending fatigue.

Bending fatigue also causes gears to change position, which affects tooth contact patterns. Figure 3.3 shows concentrated loading at gear teeth corners instead of over the entire surface. Figure 3.4 shows two tooth patterns on the ring gear, because bending fatigue caused the gear to change position.

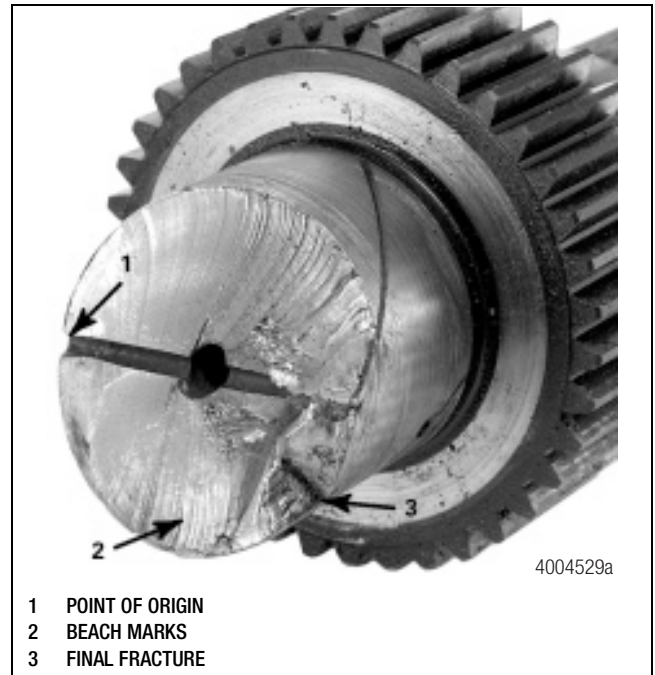
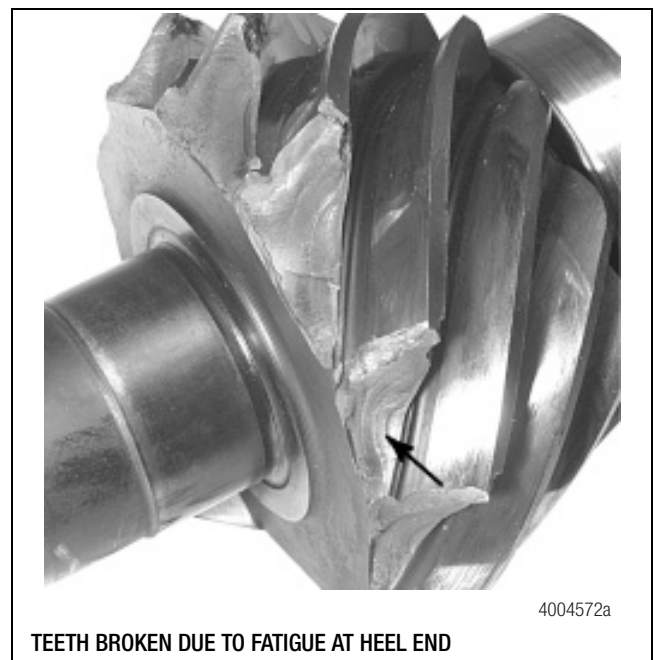

Figure 3.2



TEETH BROKEN DUE TO FATIGUE AT HEEL END

Figure 3.3

3 Failure Types and Terminology



Figure 3.4

Figure 3.5 shows what happens when parts are under bending fatigue. When the load is large, failure can occur within a few load cycles. As the load becomes smaller, more load cycles are required before failure will occur. When the load becomes even smaller, the part can withstand load cycles without damage. Also refer to **Reverse Bending Fatigue** in this section.

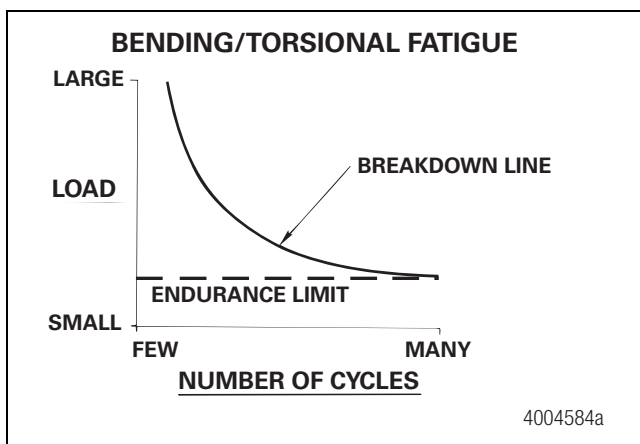

Figure 3.5

Black Spots

Refer to **Hot Spotting** in this section.

“Blue” Brake Drum

Very high operating temperatures can cause the inside of the brake drum to turn a blue color, which usually indicates that the drum is damaged.

Brinelling (Surface Fatigue)

Brinelling is a type of surface fatigue that causes bearing rollers to wear deep grooves into the mating surface. Figure 3.6. Brinelling of a u-joint usually occurs when load applications exceed the vehicle's rating, which can also cause parts to spall from uneven load application.



Figure 3.6

Brinelling can also be caused by overloads on undersized u-joints and by a breakdown of lubricant between the needle rollers and trunnion. To determine if the condition you see is brinelling, check the trunnions with your fingertips. Do you feel deep grooves? If so, brinelling has occurred.

“False” brinelling, also a type of surface fatigue, causes the needle rollers to polish the trunnion surface, unlike brinelling, which causes the rollers to wear deep grooves into the trunnion surface. To determine if the condition is “false” brinelling, check the trunnion with your fingertip. Do you feel deep grooves? If not, the condition is “false” brinelling, the trunnion isn't damaged and the u-joint is still usable.

3 Failure Types and Terminology

Burnish (Brakes)

The process of “breaking-in” new brake pads or shoes, so the linings conform to the disc or drum friction surfaces.

Bruising (Surface Fatigue)

Bruising is a type of surface fatigue that's similar to brinelling, which causes dents in a metal surface. Metal chips or large particles of dirt circulate in the lubricant and become trapped between the bearing cone, cup and rollers. Figure 3.7.



Figure 3.7

Chevron Wear Pattern

A chevron pattern contains V-shaped radial marks on a brittle fracture surface, usually on parts whose widths are considerably greater than their thickness. Also called a herringbone pattern, the points of the chevrons identify a fracture's path by pointing toward its origin. A chevron pattern is easily visible as a result of an instantaneous failure, but you can see them on some fatigue failures as well. Figure 3.8.

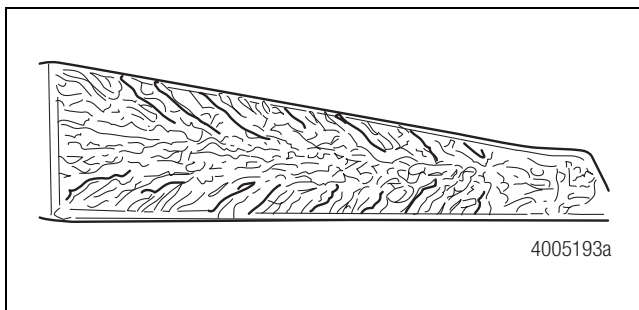

Figure 3.8

Brake Compounding

The parking brake and service brake apply at the same time, which can occur if a vehicle is not equipped with an anti-compounding valve, or the anti-compounding valve malfunctions.

Crack-Pressure

In a brake system, crack-pressure is the amount of air pressure (in psi) that an air valve requires before air is able to flow through it. A vehicle uses air valves with varying crack-pressures to maintain brake balance between all wheel ends.

Crow's Footing (Surface Fatigue)

Crow's footing is a type of surface fatigue that runs lengthwise on hypoid and amboid bevel gear teeth. Crow's footing occurs when the vehicle operates with insufficient or incorrect lubricant.

Metal-to-metal contact occurs, which causes friction to damage parts. Figure 3.9 and Figure 3.10.



Figure 3.9

3 Failure Types and Terminology



Figure 3.10

Crystalline Wear Pattern

When a sudden, severe impact load occurs, the wear pattern that forms on the surface of the part resembles crystal facets. Figure 3.11.

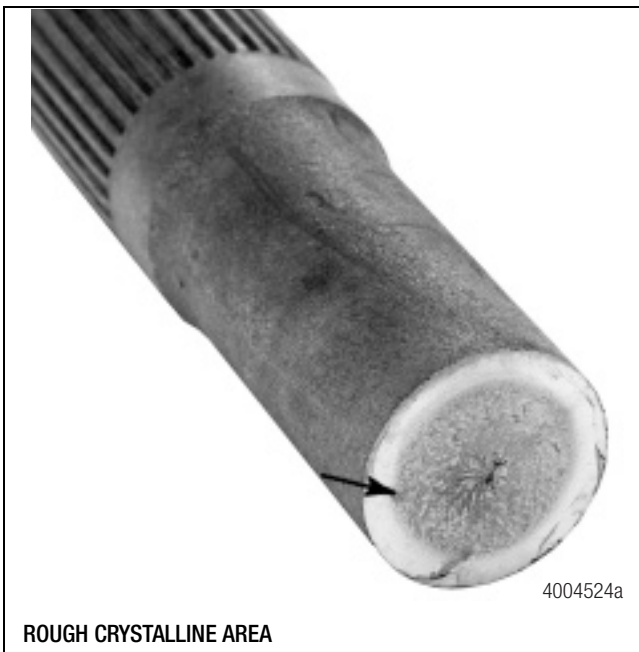

Figure 3.11

“Drive” and “Coast” Sides of Hypoid Ring Gear Teeth

The “drive” side, or front side, of the ring gear teeth is where you’d check for the tooth contact pattern, because it’s the side of the teeth that drives the vehicle down the road under power.

The “coast” side, or back side, of the ring gear teeth, only contacts the pinion when a vehicle’s decelerating; for example, when driving down a hill.

Etching (Surface Fatigue)

Etching is a type of surface fatigue that corrodes metal and leaves a dull stain on a part’s surface, because the lubricant was contaminated with water. Water can enter the carrier through breathers, or a damaged or worn seal, or as condensation from humid weather.

Water in lubricant damages bearing races and cups, and causes the hypoid gear set to wear prematurely. Figure 3.12 shows corrosion on the spigot bearing roller ends. Figure 3.13 shows etching damage on the bearing rollers, non-contact surfaces and bearing cage windows.



Figure 3.12

3 Failure Types and Terminology



Figure 3.13

Extreme Pressure (EP) Additives

Meritor axles require lubricants to contain a GL-5 level of extreme pressure (EP) additives, which protect heavily-loaded parts to help prevent surface fatigue, scoring and galling.

Flank Cracking (Surface Fatigue)

Flank cracking is a type of surface fatigue that's similar to spalling, because it causes metal to break into chips or fragments. When flank cracking occurs, initially cracks form along the length of the gear tooth. Once flank cracking appears, the tooth begins to crumble, and failure rapidly occurs. Figure 3.14.



Figure 3.14

Fatigue Fracture

Types of fatigue fractures include bending, reverse bending, torsional fatigue and root beam fatigue.

A fatigue fracture can be caused by cyclic torque overloads on a component, torsional vibration, and twisting and bending. A fracture begins at one or more points, which you can identify by the ratchet marks and subsequent beach marks that develop on the part.

Figure 3.15.

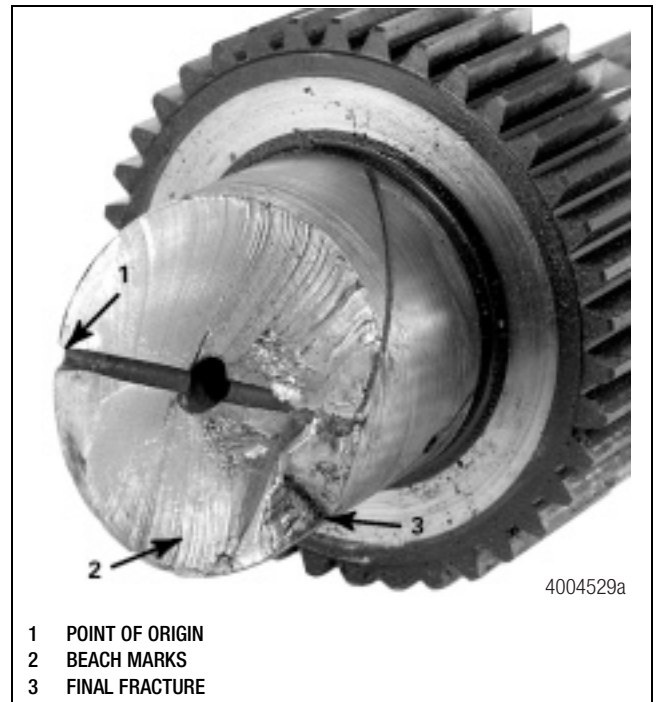

Figure 3.15

In an axle assembly, a fatigue fracture is a common failure type. A typical fracture begins when a load cycle is large, and failure will occur after only a few load applications. Reducing torque load will postpone imminent failure; however, repeated load cycles will gradually weaken a component, and it will fail.

Some common types of fatigue in an axle assembly are surface (contact) fatigue, which affects bearings and gear teeth; torsional fatigue, which affects axle shafts; bending fatigue, which affects gear teeth and axle shafts; and root beam fatigue, which affects gear teeth.

3 Failure Types and Terminology

Fretting (Surface Fatigue)

Fretting is a type of surface fatigue that's similar to brinelling. Fretting, which is caused by torsional vibration, forms sludge on a gear at or near the vibration point. The color of the sludge depends on the quality of the lubricant and type of iron oxide that's formed during torsional vibration. "Red mud" or "cocoa" sludge is abrasive and increases component wear.

Inspect the back of the gear teeth on the forward drive axle carrier. If you find a contact line on the rear side of the gear teeth on the forward drive axle carrier, fretting has occurred. Figure 3.16.



FRETTING

Figure 3.16

Frosting

Frosting is a normal wear condition on spur gear teeth that doesn't affect performance or gear life. Differences in gear tooth manufacturing tolerances cause teeth in a gear set to have different profiles. During operation, gear teeth attempt to conform to a common gear tooth profile, and frosting wear occurs.

Frosting is a grayish or yellowish white color usually found at the center of the teeth at the mating gear contact position. Light pitting on the gear teeth also may accompany frosting. As the gear continues to operate, sliding friction eventually removes frosting.

Offset Frosting

Offset frosting has the same characteristics as frosting, but appears at one side of the gear face. Offset frosting is caused by a difference in the gear tooth contact face from one side to the other, or from a slight shift in gear set loading. As the gear continues to operate, sliding friction eventually removes frosting.

Galling (Surface Fatigue)

Galling, a type of surface fatigue that occurs when two unlubricated metal surfaces rub against each other. Galling is also called "metal transfer." Figure 3.17.

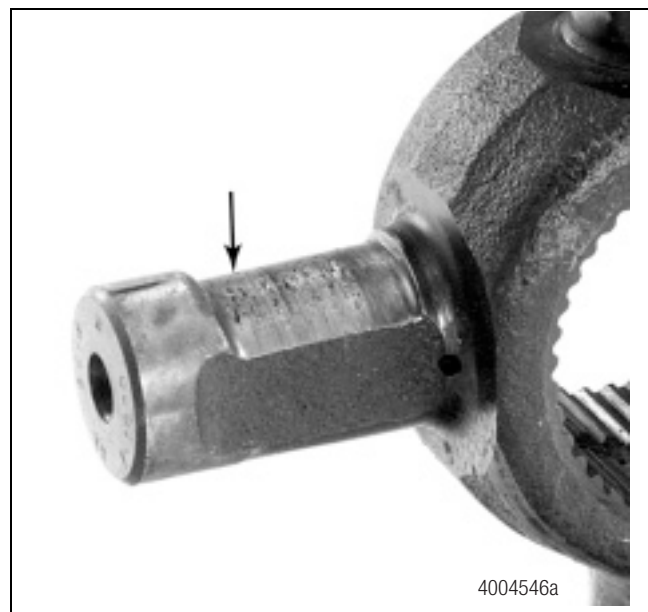

Figure 3.17

A similar type of galling is called "scuffing." Scuffing causes a bearing to wear prematurely and eventually fail. Figure 3.18 shows flat spots on the rollers and scoring on the rest of the assembly, which indicate the scuffing damage.

3 Failure Types and Terminology



Figure 3.18

Gear Ratio and Torque Multiplication

Gear ratio is the relationship between the number of turns made by a driving gear to complete one full turn of a driven gear. If a smaller driving gear has to turn three times to turn a larger driven gear once, the gear ratio is 3:1.

With a 3:1 ratio and an engine torque of 1,600 lb-ft, the gears have multiplied torque to 4,800 lb-ft (3:1) to rotate parts. How much torque is multiplied always depends on the size relationship between the driving and driven gears.

Heat Checking

Heat checking is fine lines or cracks on the surface of a brake drum or rotor. Even though heat checking is a normal condition that results when a friction surface continually heats and cools, it's important to recognize when cracks on the surface of the drum or rotor indicate damage has occurred.

Under high temperatures or overload conditions, larger cracks can develop and extend below the surface. Several heat checks aligned across the braking surface require drum replacement. Cracks that align and approach the barrel area of the rotor, or lead to the vent area, require rotor replacement.

Hot Spotting (Black Spots)

Hot spotting (black spots) can appear on a brake drum's surface uniformly (over the entire surface), on only one side or in three equidistant areas. Hot spotting requires drum replacement.

Imbalance (Brake)

Brake imbalance occurs when one or more wheel end brake doesn't perform to its designed capacity. Brake imbalance can result from pneumatic or mechanical defects in the brake system.

Impact Fracture

Refer to **Shock Load** in this section.

Load Cycle

A load cycle is the amount of torque delivered by the engine to drivetrain components over a period of time.

Gross Axle Weight Rating (GAWR)

The gross axle weight rating (GAWR) is an axle's maximum allowable weight-carrying capacity.

Gross Vehicle Weight Rating (GVWR)

The gross vehicle weight rating (GVWR) is a vehicle's maximum allowable weight rating, which includes a vehicle's total weight, fuel, fluids and full payload. Figure 3.19.

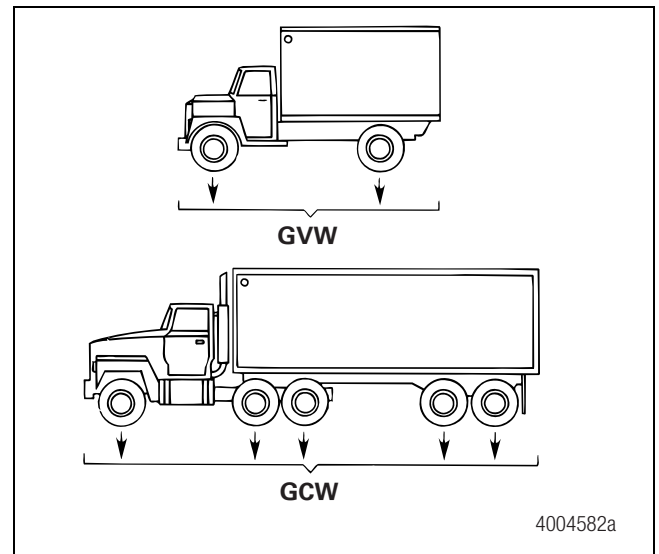

Figure 3.19

Gross Vehicle Weight (GVW)

The gross vehicle weight (GVW) is the vehicle's total weight, fuel, fluids and full payload. Figure 3.19.

3 Failure Types and Terminology

Gross Combined Weight Rating (GCWR)

The gross combined weight rating (GCWR) is a vehicle's maximum allowable load rating. GCWR includes a vehicle's total weight, fuel, driver, trailer and payload. Figure 3.19. A vehicle's GCWR typically will be higher than its GVWR, because gross vehicle weight ratings are determined by axle ratings, and a trailer has its own axles.

Gross Combined Weight (GCW)

The gross combined weight (GCW) is a vehicle's total weight plus fuel, driver, trailer and payload. Figure 3.19.

Mismatched Tires (Drive Axle)

Mismatched tires can cause excessive differential component wear. Meritor recommends matching tires to within 1/8-inch (3.175 mm) of the same rolling radius and 3/4-inch (19.05 mm) of the same rolling circumference. In addition, the total tire circumference of both driving axles should be matched to each other as closely as possible. Figure 3.20.

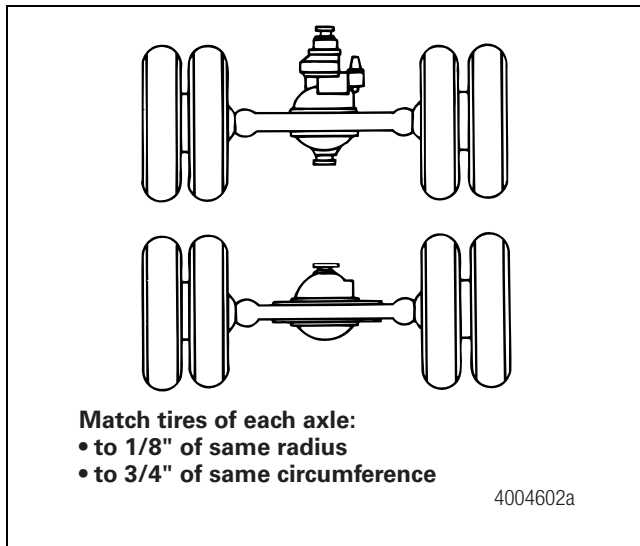

Figure 3.20

Mismatched Tandem Axle Ratios

To function correctly, the forward and rear axles must operate with axle ratios plus or minus one percent of each other. A mismatched tandem axle pair can cause the carrier to overheat, lubricant additives to deplete and axle components to wear prematurely.

Normal Wear

Components that are operated correctly, and inspected and maintained at recommended intervals, will eventually wear under normal operating conditions. This is called "normal" wear.

Also refer to **Premature Wear** in this section.

Offset Frosting

Refer to **Frosting** in this section.

Origin Point

An origin point is the location where a fracture began. A part can have a single origin point or multiple origin points.

Pitting (Surface Fatigue)

Pitting is a type of surface fatigue that forms pits, or cavities, on metal surfaces. Initially, pits may be the size of a pinhead, or even smaller. If unchecked, pitting will progress until pieces of the surface metal break from a component ("spalling") and enter the axle lubrication system.

Cyclic overloading and contaminated lubricant can damage bearing cups and rollers, and hypoid gearing. Localized pitting on drive pinion teeth can sometimes indicate that another axle component is operating out-of-position. Figure 3.21.



Figure 3.21

3 Failure Types and Terminology

Light or moderate pitting is a normal wear condition on transmission spur gear teeth that doesn't affect performance or gear life. As the gear continues to operate, sliding friction eventually removes pitting. However, heavy or deep pitting requires gear set replacement. Figure 3.22.

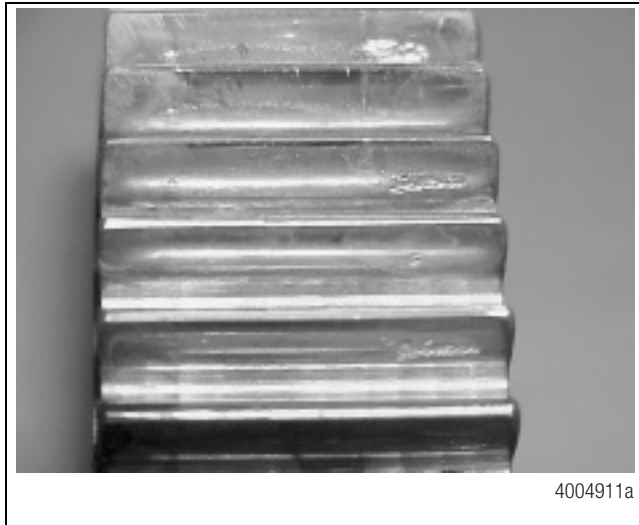

Figure 3.22

Premature Wear

Components that are operated under the following conditions will wear prematurely. For example, premature wear occurs when components are insufficiently lubricated or the lubricant is the incorrect specification. Other cause of premature wear are a vehicle is operated outside of approved equipment, load and application limits, and a vehicle is operated incorrectly or abusively.

Also refer to **Normal Wear** in this section.

Ratchet Marks

When more than one fatigue fracture occurs, beach marks form and create a raised, rough "ridge" between the origins of the fractures. This ridge is called a "ratchet mark." In this figure, you can see the ratchet mark between the first fracture, (Origin 1), and the second fracture, (Origin 2). Figure 3.23.

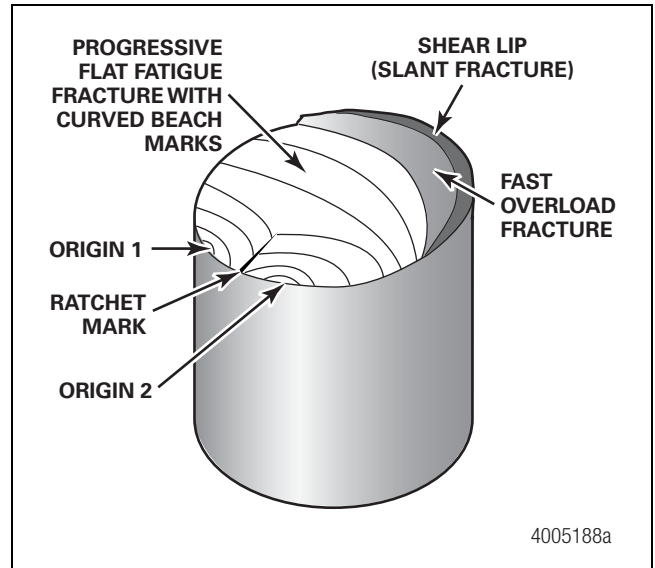

Figure 3.23

Reverse Bending Fatigue (Fatigue Fracture)

Reverse bending is a type of fatigue that breaks a component in two directions, 180 degrees apart. Beach marks occur on each side of the fractured area and move toward the center of the component. Figure 3.24.



Figure 3.24

3 Failure Types and Terminology

Root Beam Fatigue (Fatigue Fracture)

Root beam fatigue is a type of fatigue fracture that causes beach marks to originate at or near the base of a gear tooth. These marks start with a tooth that's cracked or damaged by an instantaneous shock load or repeated torque overloads, which causes localized cracks in the gear tooth roots. As mileage accumulates, initial hairline cracks expand, and gear teeth weaken progressively and ultimately break.

Figure 3.25 shows a less common root beam fatigue fracture that occurred when shock load was strong enough to crack the tooth, but not to break the entire tooth.

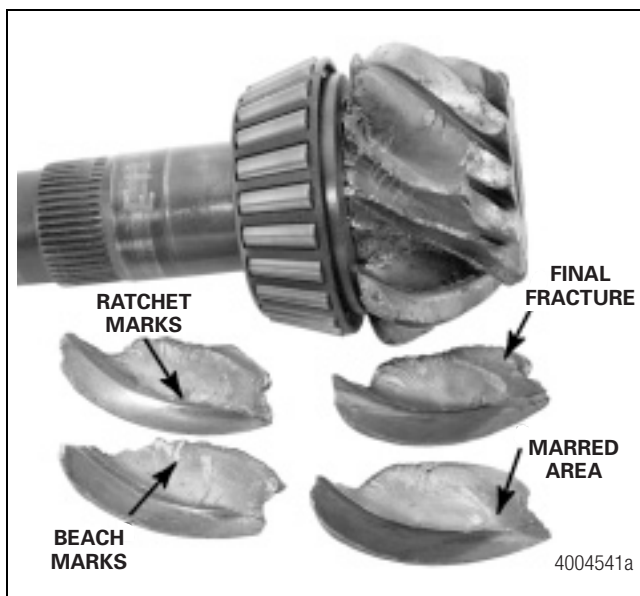

Figure 3.25

Scoring

Scoring is grooves or deep scratches on the surface of a brake drum caused by metal-to-metal contact from worn brake pads or shoes, or debris caught between the friction material and the friction surface.

Scuffing (Galling)

Refer to **Galling** in this section.

Shock Load (Impact Fracture)

Shock load, also called an "impact fracture," is a sudden and powerful force applied against a component. Shock load can destroy or damage a component immediately. Often, however, a component damaged by shock load will continue to operate, but it will wear prematurely or fail soon after the initial shock load has occurred.

Shock load causes components to crack and separate from each other. Look for a rough, crystalline finish on the separated parts. Torsional shock load results when a rapidly-applied twisting motion occurs; for example, when an excessive amount of torque is delivered to an axle shaft.

Some Causes of Shock Load

- An operator backs under a trailer with excessive force. A vehicle's spinning wheel hits dry pavement. An operator misses a shift.
- An operator speeds up the engine and rapidly releases the clutch ("popping the clutch"), which causes an immediate force, or load, to the driveline.
- An operator locks the IAD when the wheels are spinning, which can damage the clutch collar and mating shaft splines, and other carrier components.

Figure 3.26 shows a pinion gear damaged by shock load. The fracture has a rough, crystalline appearance and is broken at a 45-degree angle.

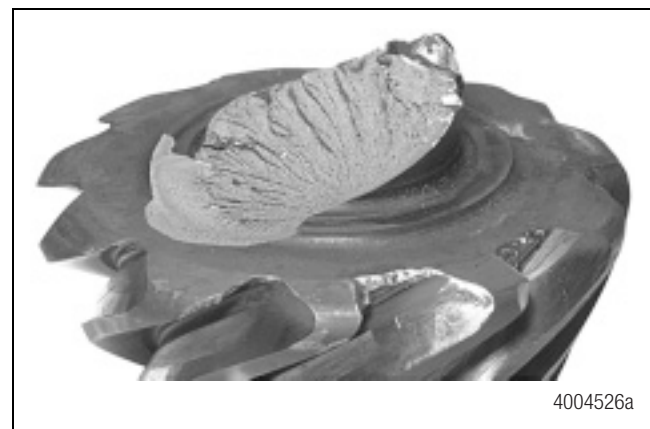

Figure 3.26

3 Failure Types and Terminology

Figure 3.27 shows a hypoid gear seat damaged by shock load. Typically, the first tooth breaks at the heel, the second tooth breaks completely, and the third tooth breaks at the toe. The figure shows how two of the teeth were damaged by the pinion rubbing against the area where the teeth broke.

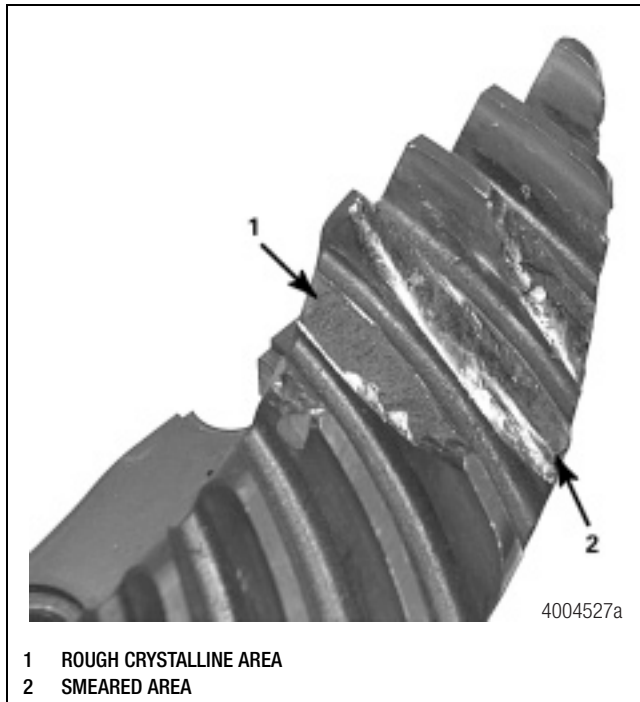

Figure 3.27

Figure 3.28 and Figure 3.29 show an axle shaft damaged by shock load that fractured perpendicular to its centerline, which caused a rough, crystalline surface to form on the shaft. This type of failure is also called “torsional shear.” If the fracture is at a 45-degree angle to the centerline, the damage is called “torsional tensile” failure.

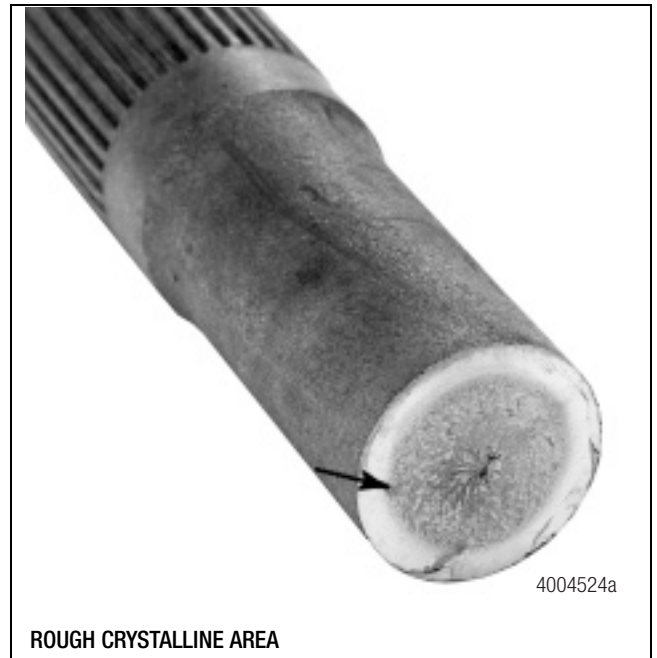

Figure 3.28

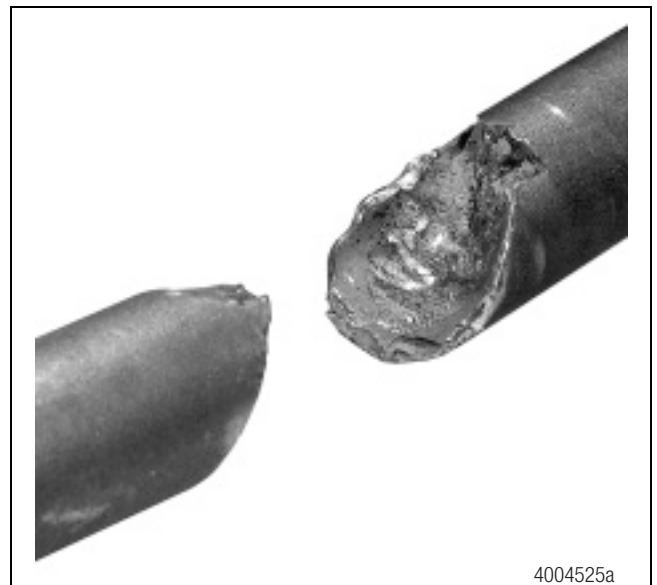

Figure 3.29

3 Failure Types and Terminology

Spalling (Surface Fatigue)

When the metal surface of a component breaks into chips or fragments as a result of wear fatigue, the condition is called “spalling.” Spalling is a type of surface fatigue and is evident in the advanced stages of pitting, which is the beginning of surface fatigue. On u-joint trunnions, spalling usually affects those opposite each other. Spalling also damages transmission spur gear teeth. Starting as small pitted areas, spalling can progress rapidly.

Some causes of spalling are prolonged stress from excessive load applications; or the components operate with no lubricant or a lubricant that doesn't meet the correct specification. Spalling can also occur when components are operated beyond the maximum mileage range. Figure 3.30 and Figure 3.31.



Figure 3.30

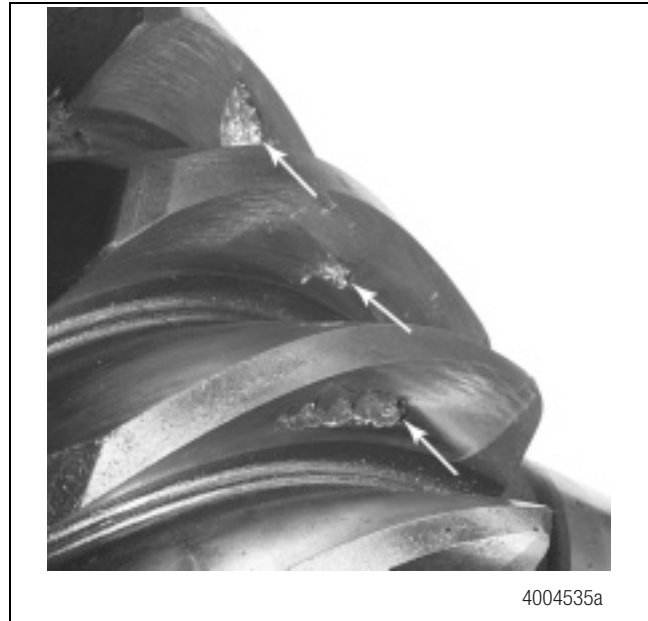

Figure 3.31

Spinout

Spinout, also called “excessive differentiation,” typically occurs when a tandem axle loses traction, and the inter-axle differential (IAD) is in the unlocked position.

During spinout, the differential pinions spin at a high rate of speed, which causes the pinions to be insufficiently lubricated. Heat created from friction between the differential pinion gears and cross legs can damage the axle.

Other causes of spinout, or excessive differentiation, are mismatched tires and mismatched tandem axle ratios.

Stress Riser

A stress riser is a condition caused by fatigue that deforms metal on a component's surface. For example, welding on an axle creates intense heat that changes the characteristics of the metal that surrounds the weld, and an incorrect weld caused fatigue to occur. In Figure 3.32, you can see that fatigue had created a stress riser, which caused the axle to fail.

3 Failure Types and Terminology

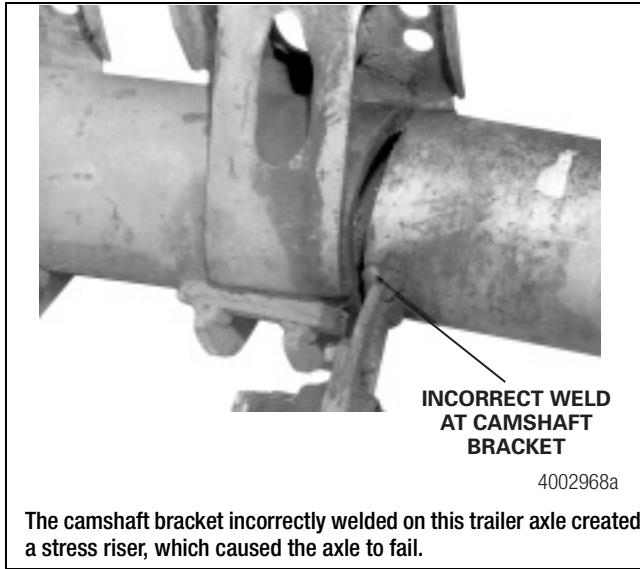

Figure 3.32

Surface (Contact) Fatigue

Surface (contact) fatigue is a broad classification for a number of different types of damage that can occur on the load-carrying surface of a component. Types of surface fatigue include pitting, spalling, flank cracking, galling, crow's footing, scuffing, etching, bruising, fretting and brinelling.

Surface fatigue is usually caused by cyclic overloading on bearings or gear teeth, and contaminated lubricant can accelerate surface fatigue. Figure 3.33 and Figure 3.34.



Figure 3.33

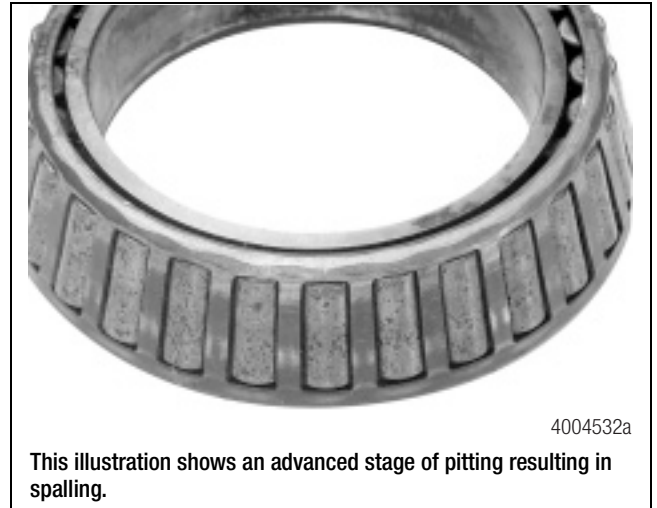

Figure 3.34

When the surface (contact) fatigue load is large, failure can occur within only a few load cycles, as shown by the breakdown line in Figure 3.35. As the load becomes smaller, the number of cycles required for the part to fail increases. However, even smaller load cycles eventually will result in a surface fatigue failure. The fatigue characteristics of bearings subject to surface loads also follow the breakdown line.

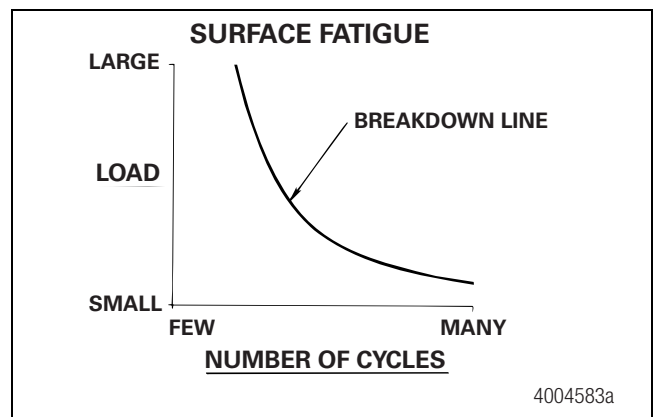

Figure 3.35

Torque

Torque is a turning or twisting force that may or may not produce motion. For example, engine power applies torque to the driveline; the driveline delivers torque to the drive axles; the vehicle moves. The difference between torque and horsepower: Torque may or may not produce motion. However, motion is always required to produce horsepower. Torque is usually measured in lb-ft.

3 Failure Types and Terminology

Torsional Fatigue (Fatigue Fracture)

Unlike bending fatigue, torsional fatigue causes excessive twisting that weakens components. Usually, you'll see beach marks and ratchet marks at the fracture's origin point. However, if torsional fatigue occurs on a splined shaft, you'll see that the fracture started at the base of each spline. Figure 3.36 shows a drive shaft damaged by torsional fatigue. As the splines continued to weaken, the metal formed a star-shaped radial pattern, eventually breaking the shaft at the center.



Figure 3.36

Torsional Vibration

Torsional vibration is a twisting and untwisting action in a shaft that's caused by the application of engine power (torque) or incorrect driveline phasing or angles. Torsional vibration can cause premature wear damage to all drivetrain components.

Witness Marks

Witness marks are evidence of fatigue (beach marks, ratchet marks, for example), abusive machining, burn marks, corrosion, wear damage, etc.

Working Angle

When two driveline components intersect at a Cardan u-joint, the angle that's formed is called a "working angle."

Parts Analysis Overview

WARNING

Wear safe eye protection to prevent serious eye injury when you inspect heavy vehicle components.

This section provides a parts analysis process to help you determine why drive axle components fail during operation, what to look for when you inspect the parts, and how to help prevent failures from occurring again.

Most of the time, you can find the answers you need by visually inspecting a failed component. Sometimes, however, this process may require specialized knowledge or equipment.

Why a product fails can be difficult to determine, and a failure can vary in appearance from vehicle to vehicle. Failures in models from the same manufacturer can also vary, so it's important to use the information presented here as a guide, not a rule, when you perform parts analysis inspections.

Common Causes of Drive Axle Component Failures

Cause	Wear Damage That Can Occur
A vehicle is operated outside Meritor's approved application or vocation capabilities.	Fatigue fracture, galling, spalling, shock load, overheated lubricant
The vehicle was modified from its original configuration without Meritor's approval.	Fatigue fracture, galling, spalling, shock load, overheated lubricant
A driver operates a vehicle incorrectly or abusively.	Fatigue fracture, shock load, spinout, overheated lubricant
An operator backs under a trailer with excessive force.	Fatigue fracture, shock load
A vehicle's spinning wheel hits dry pavement.	Fatigue fracture, shock load
An operator misses a shift.	Fatigue fracture, shock load
An operator speeds up the engine and rapidly releases the clutch ("popping the clutch").	Fatigue fracture, shock load
An operator locks the IAD when the wheels are spinning.	Fatigue fracture, shock load
An operator excessively "rocks" the vehicle.	Fatigue fracture, shock load
The vehicle is operated with mismatched tire ratios, mismatched tandem axle ratios, or both.	Spinout, galling, overheated lubricant
The component is insufficiently lubricated, or the incorrect lubricant is installed.	Lubricant overheats, fatigue fracture, galling (crow's footing), pitting
The lubricant is contaminated.	Pitting, etching, spalling, overheated lubricant

4 Drive Axles

A Vehicle is Operated Outside its Application or Vocation

Axles operated under conditions that exceed their design capacity can wear prematurely. Fatigue, which can result from load cycles that exceed a carrier's gross vehicle weight rating (GVWR) or gross combined weight rating (GCWR), can cause an axle to fail.

Figure 4.1.

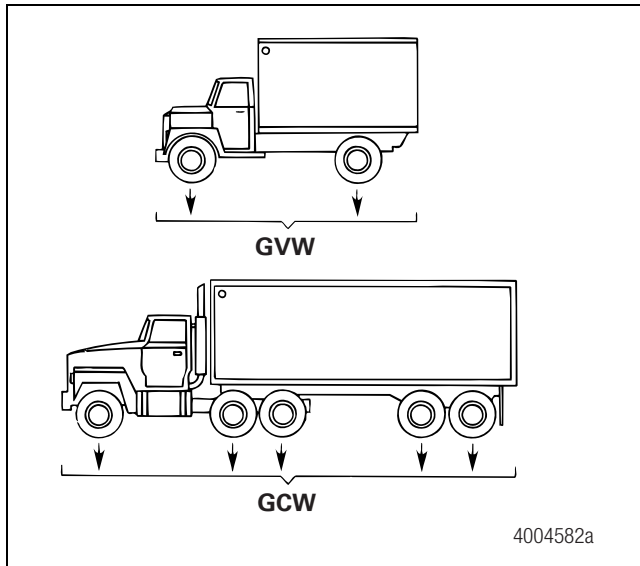

Figure 4.1

Exceeding an Axle's Maximum Gross Axle Weight Rating (GAWR)

Operating a vehicle at a weight that exceeds a carrier's gross axle weight rating (GAWR) will damage components, because a carrier is rated for a specific application. For example, if a vehicle is operated on an unapproved road surface for the application, rolling resistance increases, and more torque is required to move the vehicle forward. Over a period of time, torque overload occurs and damages components. Figure 4.2.

Operational overload is a main cause of axle housing damage, which occurs when the vehicle is loaded in excess of its GAWR. When GAW increases, axle housing life decreases.

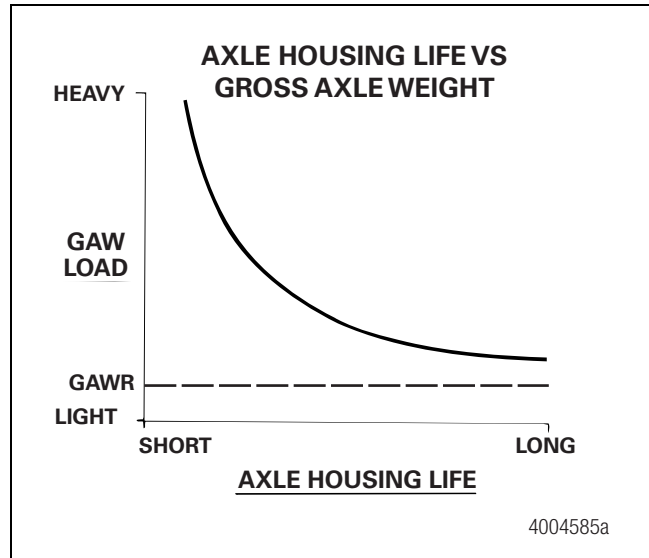

Figure 4.2

Axle Fatigue

Three types of fatigue are common to axle components: surface (contact) fatigue, which affects bearings and gear teeth; torsional fatigue, which affects shafts; and bending fatigue, which affects gear teeth and shafts.

The type of damage that occurs to components depends on the type of fatigue that occurs. Bearing and gear tooth damage from surface (contact) fatigue is different than damage to axle shafts caused by bending fatigue.

Surface (Contact) Fatigue

When the surface (contact) fatigue load is large, failure can occur within only a few load cycles, as shown by the breakdown line in Figure 4.3. As the load becomes smaller, the number of cycles required to destroy the part increases.

However, smaller load cycles will eventually result in a surface fatigue failure. The fatigue characteristics of bearings subject to surface loads also follow the breakdown line. Figure 4.3.

Figure 4.4 shows what happens when parts are under bending or torsional fatigue. When the load is large, failure can occur within a few load cycles. When the load becomes even smaller, the part can withstand load cycles without damage.

Gears are subjected to both bending and surface loads. Surface fatigue affects lightly loaded gears. As the load increases, damage is caused by bending fatigue.

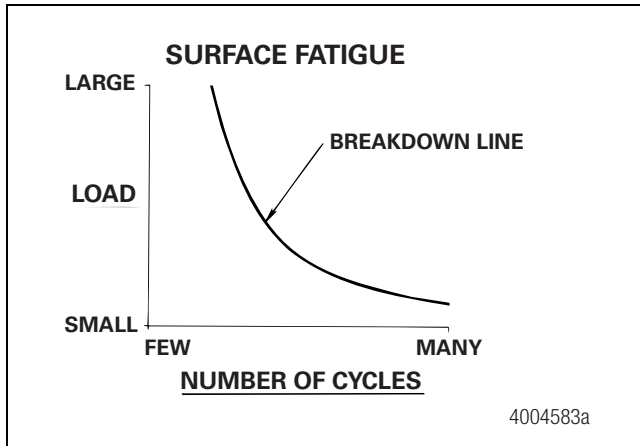

Figure 4.3

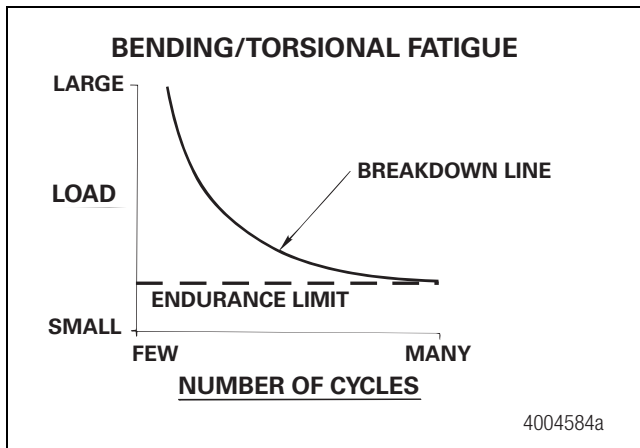

Figure 4.4

Torsional Fatigue (Fatigue Fracture)

Unlike bending fatigue, torsional fatigue causes excessive twisting that weakens components. Usually, you'll see beach marks and ratchet marks at the fracture's origin point. However, if torsional fatigue occurs on a splined shaft, you'll see that the fracture started at the base of each spline.

Figure 4.5 shows a shaft damaged by torsional fatigue. As the splines continued to weaken, the metal formed a star-shaped radial pattern, eventually breaking the shaft at the center.

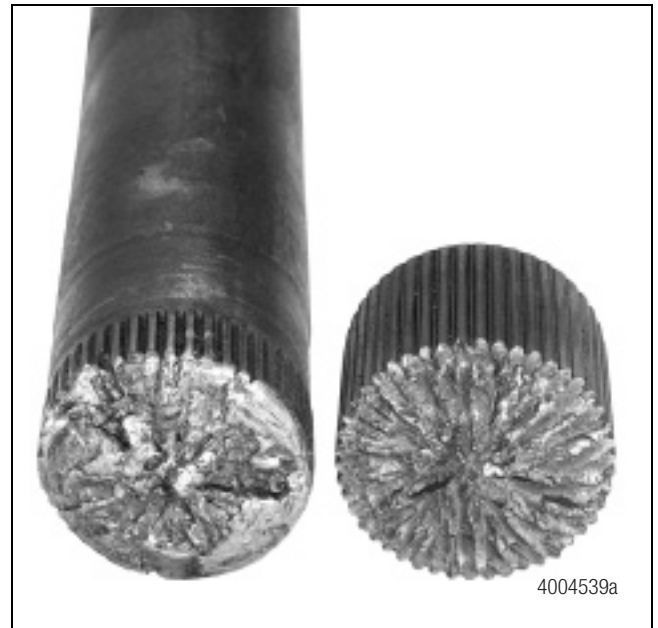

Figure 4.5

Bending Fatigue (Fatigue Fracture)

Bending is a type of fatigue fracture that occurs when a shaft is subjected to both torsional and bending fatigue at the same time. Beach marks form and usually point toward the origin of the fracture, which represents fatigue fracture cycles that occurred before the component failed completely. Figure 4.6 shows beach marks on an axle shaft that indicate bending fatigue caused the fracture.

Bending fatigue also causes gears to change position, which affects tooth contact patterns. Figure 4.7 shows concentrated loading at gear teeth corners instead of over the entire surface. Figure 4.8 shows two tooth patterns on the ring gear, because bending fatigue caused the gear to change position.

4 Drive Axles

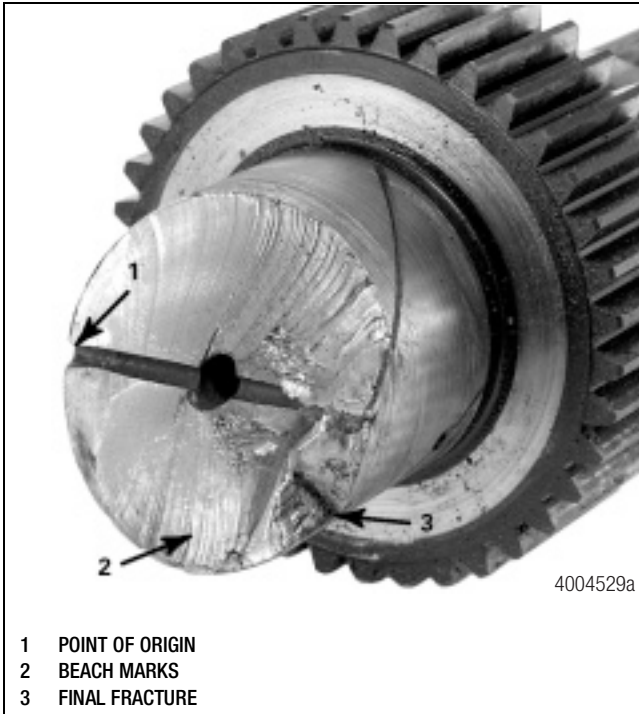

Figure 4.6



Figure 4.8

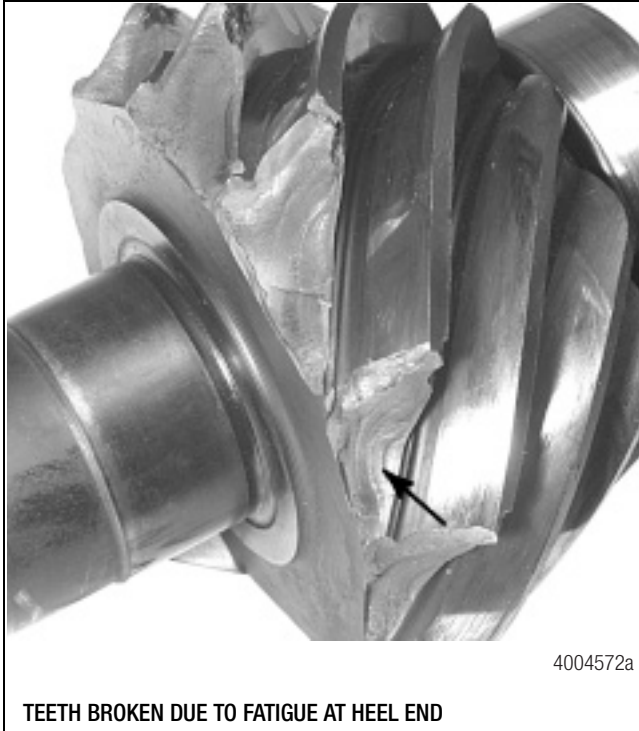

Figure 4.7

Figure 4.9 shows what happens when parts are under bending fatigue. When the load is large, failure can occur within a few load cycles. As the load becomes smaller, the number of cycles required to damage the part increases. When the load becomes even smaller, the part can withstand load cycles without damage.

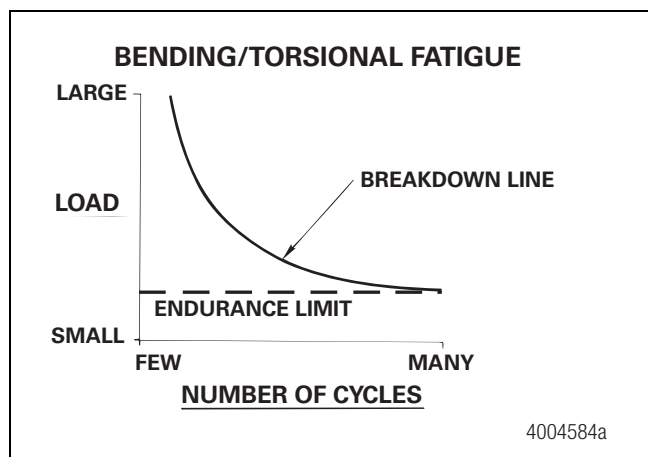

Figure 4.9

Spinout

Spinout (also called “excessive differentiation”) typically occurs when a tandem axle loses traction, and the inter-axle differential (IAD) is in the unlocked position. If an operator attempts to lock the IAD when the wheels are spinning, severe damage to the clutch collar, mating shaft splines and other carrier components will occur.

During spinout, the differential pinions turn at almost twice the speed of the drive shaft, which causes the pinions to be insufficiently lubricated. Heat created from friction between the differential pinion gears and cross legs can damage the axle. Figure 4.10 and Figure 4.11.

The inter-axle differential (IAD) is more susceptible to damage from spinout than the main differential, which operates at lower speeds and is submerged in oil.

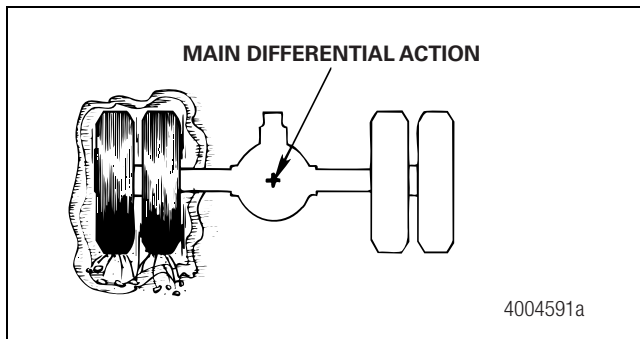

Figure 4.10

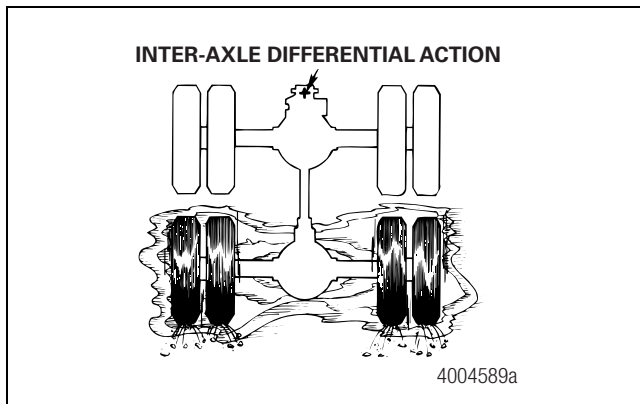

Figure 4.11

In axles without an oil pump, centrifugal force displaces all of the oil between the cross and pinions, and heat created by friction causes these parts to seize. Sometimes differential pinions become so hot, they weld to the mating surfaces of the differential assembly.

Other causes of spinout include loss of traction when backing under a trailer, most often on wet and slippery pavement, or unpaved surfaces; starting on a slippery surface; operating on a slippery surface, especially on a hill or grade; and mismatched tire and tandem axle ratios.

Examples of Typical Spinout Damage

Pinion Cross Failure

Figure 4.12, Figure 4.13, Figure 4.14, Figure 4.15 and Figure 4.16 show how spinout caused a pinion cross to fail. Damage progresses from normal wear, to moderate premature wear, and then to heavy wear; and finally, the pinion cross fails.

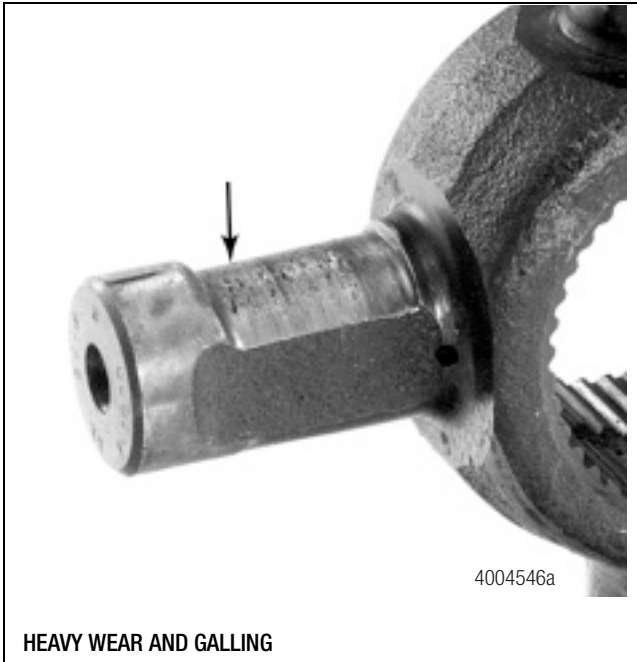

Figure 4.12



Figure 4.13

4 Drive Axles



HEAVY WEAR AND GALLING

Figure 4.14



PINION CROSS FAILURE

Figure 4.15

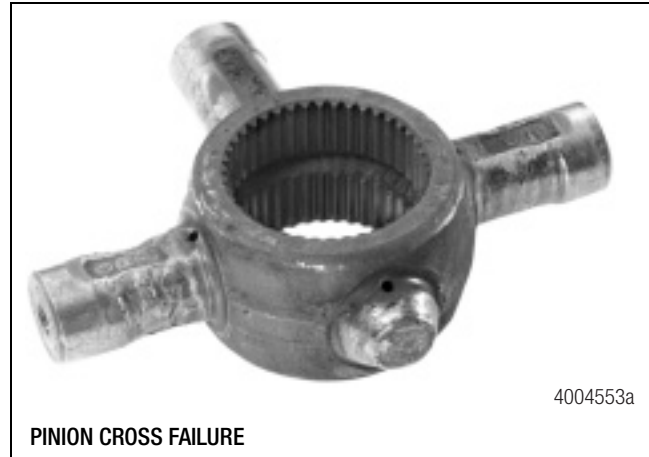

PINION CROSS FAILURE

Figure 4.16

Helical Gear Journal

Friction from spinout can cause galling at the helical gear journal and the rear side gear journal. Figure 4.17. If spinout damaged the rear side gear, perform this inspection.



Figure 4.17

Rear Side Gear

Figure 4.18 shows a rear side gear that's been damaged by spinout. If the rear side gear bearing fails, you'll find signs of overheating on the outside of the carrier.

Spinout also caused the rear side gear to weld to the input shaft, and the bearing is scored. This damage resulted from a spinning rear wheel and a stationary forward axle, which prevented the forward gear set from lubricating the rear side gear. Look for localized heat damage and burned lubricant. Figure 4.19.



Figure 4.18



Figure 4.19

Mismatched Tire Ratios

Mismatched tire ratios can cause spinout to occur. Meritor recommends matching tires to within 1/8-inch (3.175 mm) of the same rolling radius and 3/4-inch (19.05 mm) of the same rolling circumference. In addition, the total tire circumference of both driving axles should be matched to each other as closely as possible. Figure 4.20.

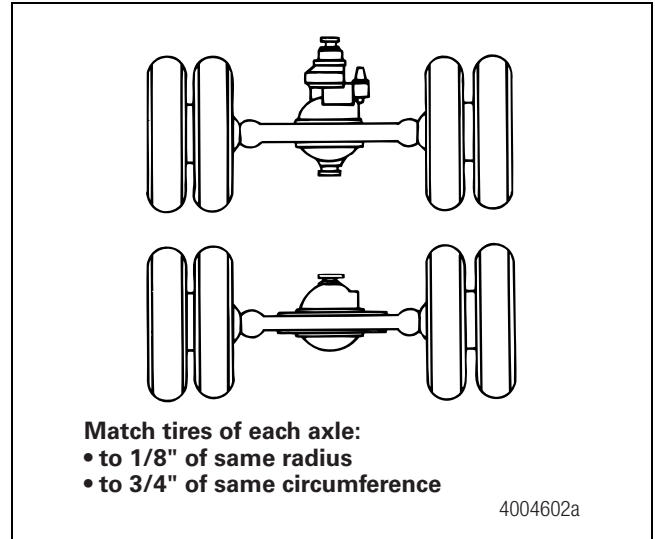

Figure 4.20

Mismatched Tandem Axle Ratios

To function correctly, the forward and rear axles must operate with axle ratios within one percent. A mismatched tandem axle pair can cause the carrier to overheat, the hypoid gear set to wear, metal debris to collect on the magnetic drain plug, lubricant additives to deplete, and the axle to wear prematurely. Mismatched tandem axle ratios can also cause excessive differential component wear.

Torsional Vibration

Torsional vibration is a twisting and untwisting action in a shaft that's caused by intermittent applications of engine power or torque. However, severe torsional vibration can cause premature wear damage to drivetrain components, and incorrect driveline angles or out-of-phase drivelines can increase torsional vibration in a drivetrain.

Shock Load

Shock load is a sudden and powerful force applied against a component. Shock load can destroy or damage a component immediately. Often, however, a component damaged by shock load will continue to operate, but it will wear prematurely or fail soon after the initial shock load occurred. Shock load causes components to crack and separate from each other. Look for a rough, crystalline finish on the separated parts. Figure 4.21 shows an axle shaft damaged by shock load.

4 Drive Axles

Shock load causes components to crack and separate from each other. Look for a rough, crystalline finish on the separated parts. Torsional shock load results when a rapidly-applied twisting motion occurs; for example, when an excessive amount of torque is delivered to an axle shaft.

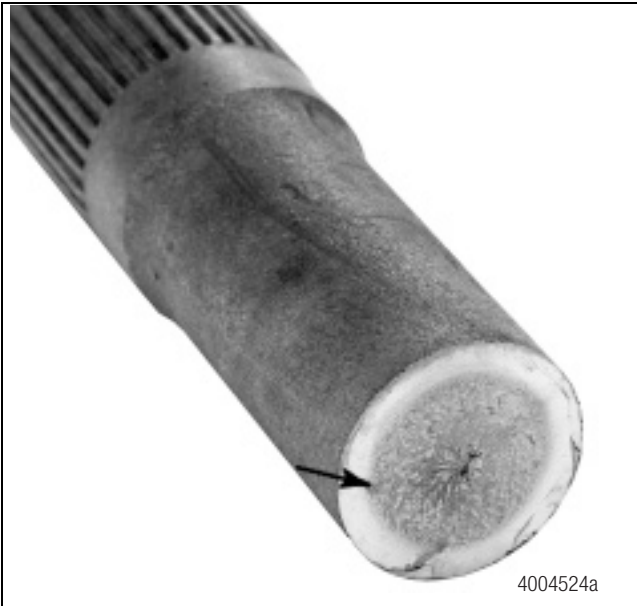

Figure 4.21

Figure 4.22 shows a pinion gear damaged by shock load. The fracture has a rough, crystalline appearance and is broken at a 45-degree angle.

Figure 4.23 shows a hypoid gear set damaged by shock load. Typically, the first tooth breaks at the heel, the second tooth breaks completely, and the third tooth breaks at the toe. The figure shows how two of the teeth were damaged by the pinion rubbing against the area where the teeth broke.

Figure 4.24 and Figure 4.25 show an axle shaft damaged by shock load that fractured perpendicular to its centerline, which caused a rough, crystalline surface to form on the shaft. This type of failure is also called “torsional shear.” If the fracture is at a 45-degree angle to the centerline, the damage is called “torsional tensile” failure.

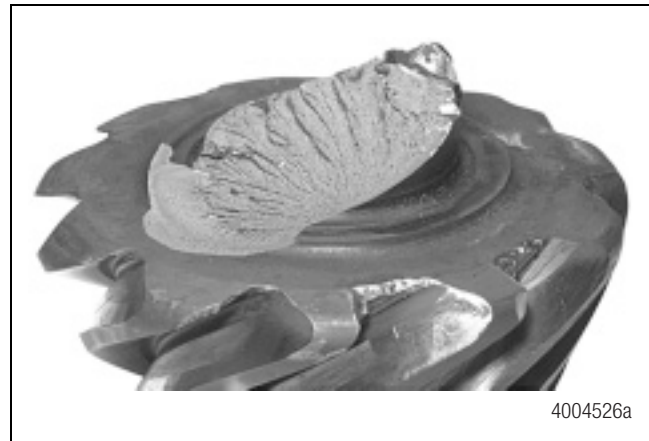

Figure 4.22

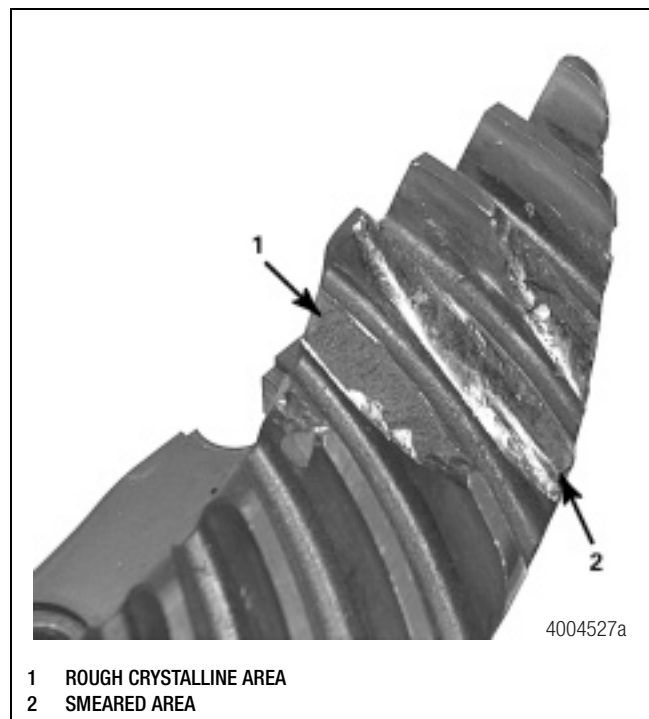

Figure 4.23

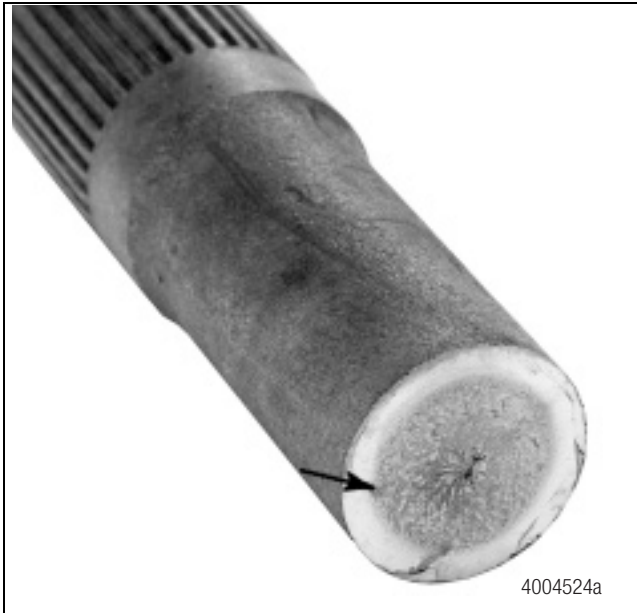

Figure 4.24

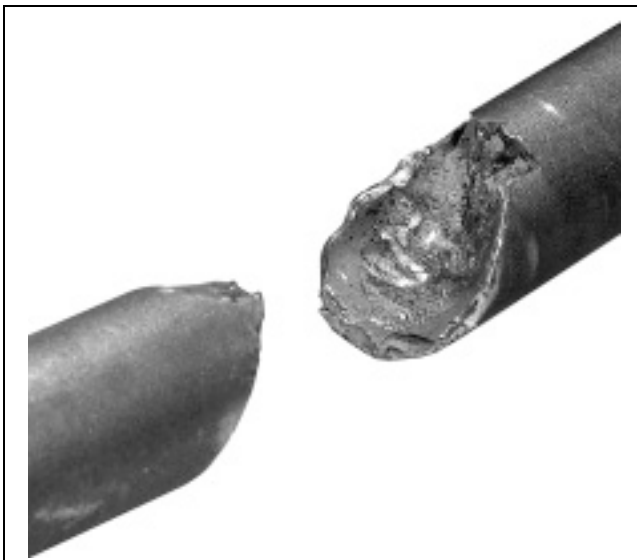

Figure 4.25

Unapproved Vehicle or Powertrain Modifications

Unapproved modifications to a vehicle's original configuration — for example, horsepower, torque, vocation, suspension, transmission ratio, axle ratio, retarders and tire size — can result in premature wear and damage to components, as well as unsafe operating conditions.

The Vehicle Isn't Maintained According to Meritor's Recommended Maintenance Practices

Premature wear and damage to components will result if a vehicle is not correctly maintained according to Meritor's recommended maintenance intervals and lubricant specifications. For example, the lubricant is not specified by Meritor, the lubricant is contaminated, or there's insufficient lubricant in the system.

The Lubricant is Incorrect

A lubricant that doesn't meet Meritor's specifications will cause components to wear prematurely. Meritor axles require lubricants to contain a GL-5 level of EP additives, which protect heavily-loaded parts to help prevent surface fatigue, scoring, galling and welding of moving parts.

Installing a lubricant without EP additives causes hypoid gear teeth to wear to a thin edge. If detected early, you'll see that a crow's footing pattern formed on the gear teeth. Figure 4.26 and Figure 4.27.

Also, EP additives will deplete when a carrier overheats. For example, the EP additive in drive axle lubricant begins to deplete when the carrier's temperature is consistently above 250°F (121°C). The higher the temperature, the faster the additive depletes. Crow's footing, a result of overheating, causes lines and ridges to appear lengthwise on hypoid and amboid bevel gear teeth.

Figure 4.28, Figure 4.29, Figure 4.30 and Figure 4.31 show drive axle components damaged by burned lubricant and melted gear teeth.

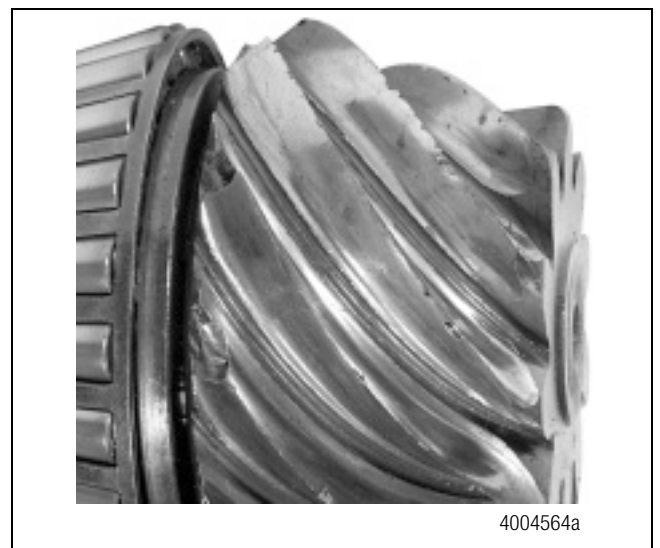

Figure 4.26

4 Drive Axles



Figure 4.27



Figure 4.29



Figure 4.28

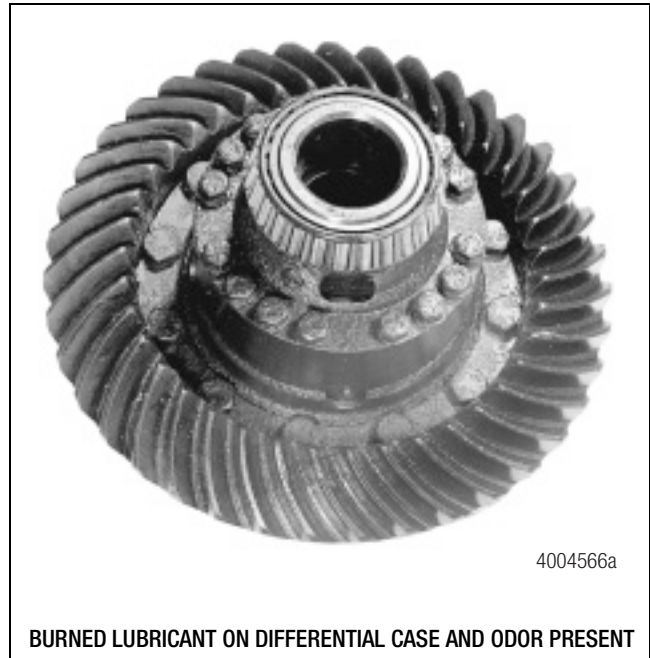

Figure 4.30

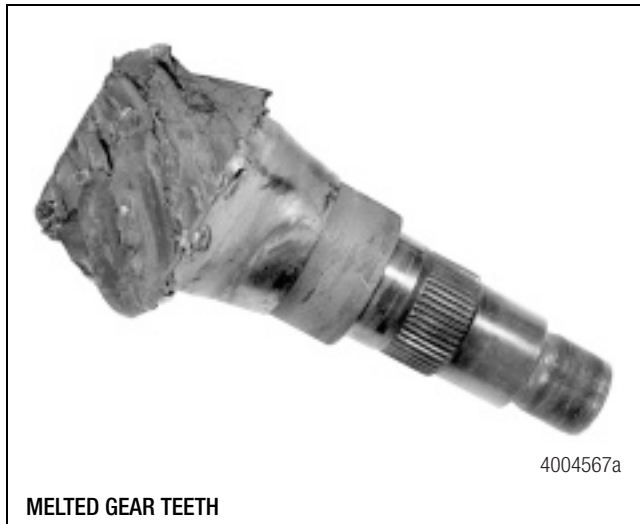

Figure 4.31

Contaminated Lubricant

Lubricant contaminated with water, dirt or wear particles will damage the mating surfaces of components, particularly bearing surfaces. Figure 4.32 and Figure 4.33. Other areas of concern are seals and breathers.



Figure 4.32

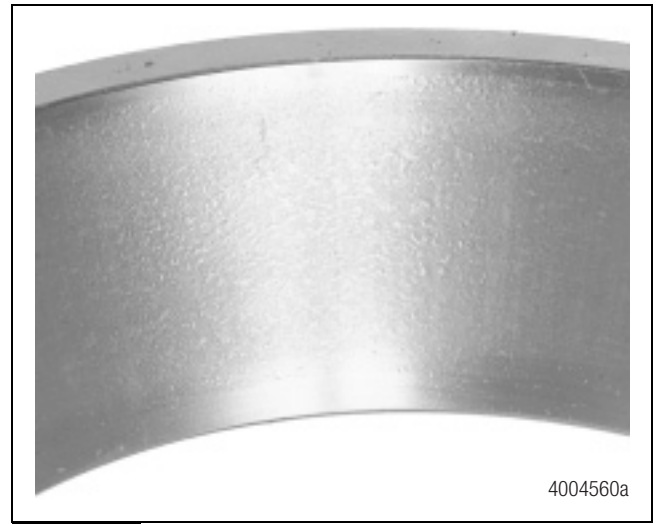

Figure 4.33

Low Lubricant Levels

If a vehicle was insufficiently lubricated, damage can occur shortly afterward. Friction from parts generates heat and causes temperatures to increase considerably. If a vehicle was operated with no lubricant in the system, you'll find damaged gear teeth, as well as blueing on parts, which resulted from high operating temperatures due to friction. Figure 4.34.

Low lubricant levels can result from leaking seals, which can be caused by a clogged axle housing breather. Figure 4.35.



Figure 4.34

4 Drive Axles

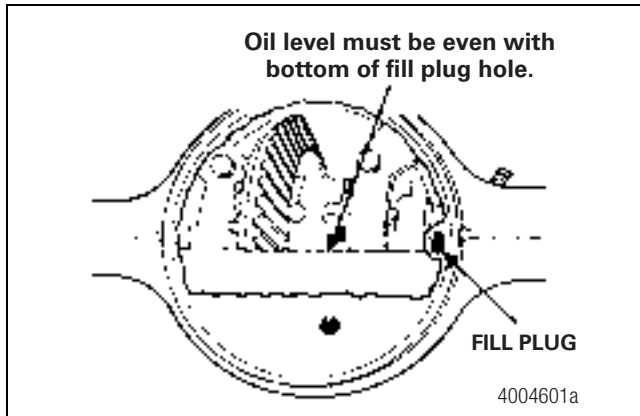

Figure 4.35

Metal Particles on the Magnetic Fill/Drain Plug

During maintenance procedures it is normal to find fine metal particles adhering to the magnetic fill/drain plug. These particles are generated under normal operating conditions, and the magnets attract the particles and prevent them from passing through the gear mesh or bearings.

However, larger metal particles adhering to the fill/drain plug, such as gear teeth, bearing fragments, thrust washer fragments and metal shavings, are not a normal condition.

It is important to be able to identify the differences between fine and large metal particles to determine how they occurred and what repairs may be required to prevent component damage.

Remove and Inspect the Magnetic Fill/Drain Plug

Remove the magnetic fill/drain plug. Inspect the metal particles adhering to the plug. Use the Guidelines in this technical bulletin to determine if the metal particles you find are fine (a normal condition) or larger (a condition that is not normal).

Guidelines

Fine Metal Particles

The fine metal particles attached to the magnetic plug in Figure 4.36 are normal. Internal components can shed fine metal wear particles at a steady rate, especially during the break-in period. In addition to the magnetic plugs, Meritor axles are also equipped with four to six magnets in the housing to capture debris generated during extended maintenance intervals used today.

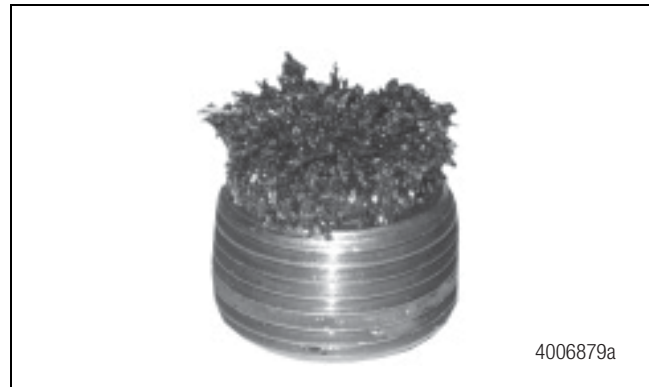

Figure 4.36

Thrust Washer Fragments

Figure 4.37 shows a main differential side gear thrust washer fragment. The loss of a fragment from the thrust washer is not detrimental to the operation of the axle and does not require disassembly, inspection and replacement of the axle.

If you are concerned about additional fragments or component damage, perform an oil sample analysis. If the iron content of the sample is above 1000 parts per million (ppm), inspect and repair the carrier as necessary.



Figure 4.37

Metal Shavings

Figure 4.38 shows metal shavings which are remnants from the housing machining process. Metal shavings adhere to the magnets and are not detrimental to the operation of the axle. It is not necessary to perform further inspections or remove the carrier for cleaning.



Figure 4.38

Bearing and Gear Tooth Fragments

Figure 4.39 and Figure 4.40 show bearing and gear tooth fragments. Both indicate a significant issue that can result in component damage. Immediately remove the carrier, inspect it, and perform required repairs.



Figure 4.39



Figure 4.40

Check the Condition of the Oil

Most drive axle oils are either golden brown or deep red in color. If the oil looks “milky brown” or has a “copper” color, the oil is contaminated.

The oil samples in Figure 4.41 show how the lubricant may appear during inspection. Refer to Oil Conditions for guidelines.

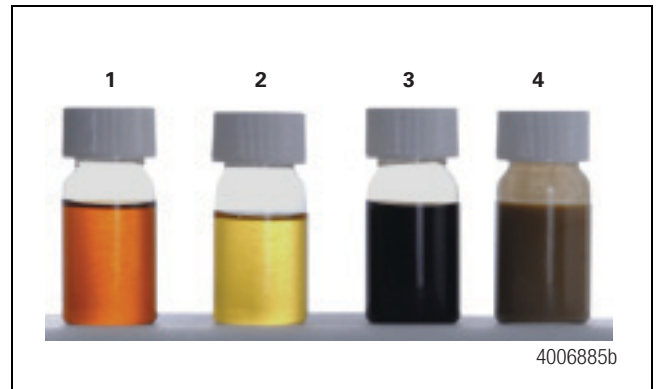

Figure 4.41

Oil Conditions

Sample 1: Red

Sample 2: Golden Brown

Both the red and golden brown samples show the typical appearance of new GL5 EP oils that meet the SAE J2360 specification. They usually are golden brown, but also can be red in color. Figure 4.41.

Sample 3: Black

This black sample is used-oil with significant time and mileage. The color change from red or golden brown to black is the result of a normal chemical process that occurs as the additive package in the oil degrades. The black color does not necessarily indicate that the oil’s useful life has been exhausted. Perform a lubrication analysis to verify that the oil can still be used in the carrier. Figure 4.41.

Sample 4: “Milky” Brown

This “milky” brown sample indicates the oil is contaminated with significant moisture well above the allowable change specification of >0.3%. Change the oil immediately. Also try to determine how the moisture entered the assembly and consider extending the breathers on applications where this occurs. Figure 4.41.

4 Drive Axles

Copper (Sample Not Shown)

A copper color indicates that the drive helical support thrust washer may have disintegrated. Use care when you evaluate the oil, as a copper color can be confused with the normal color of some oils. Perform a lubrication analysis to determine the amount of copper in the lubricant before you perform a physical inspection.

- **If the copper level is above 600 ppm:** Remove the input shaft assembly and inspect the drive helical support thrust washer.
- **If the copper level is 600 ppm or below:** You can continue to use the oil.

Table B: Used-Oil Analyses (ppm = parts per million)

Iron (Fe)	If the level is 1000-1500 ppm, resample the oil. If resampling indicates that the iron level is above 1000 ppm, drain and replace the oil. If the level is above 1500 ppm, drain and replace the oil.
Silicon (Si)	If the level is greater than 100 ppm, drain and replace the oil.
Water (H2O)	If the level is greater than 0.3%, drain and replace the oil.
Phosphorus (P)	If the level is less than 900 ppm, it is possible that the oil is not a GL-5 gear oil. Contact the lubricant manufacturer or Meritor Materials Engineering to determine the expected phosphorus level of a new oil sample. Only GL-5 type gear oils are approved for use in Meritor differentials.
Toluene Insolubles	If the level is greater than 0.100 wt.%, drain and replace the oil.

Components Overheat During Operation

How Overheating Can Occur

- Lubricant is added over the assembly's fill line during maintenance procedures.
- The engine rating or torque rating was increased from the vehicle's original specification.
- Air flow is restricted, which decreases ventilation through the system.
- A vehicle's operated with incorrect driveline angles or mismatched tires.
- A vehicle's operated with a low lubricant level or the incorrect lubricant.

Parts Analysis Process

This section provides a parts analysis process to help you determine why drive axle components failed during operation, what to look for when you inspect the parts, and how to help prevent failures from occurring again. Failures that cause primary damage are identified under **What To Look For**.

Bearing Adjusting Ring

Cause of Failure

Root beam fatigue damaged the drive pinion.

What To Look For

Primary Damage: Root beam fatigue caused the drive pinion teeth to fracture and penetrate the gear teeth. Figure 4.42.

The adjusting ring on the flange side of the carrier pushed outward at the cap-to-case area and bent the main differential bearing cap cotter pin. Figure 4.43.

Prevention

Operate the vehicle within its approved application and weight limits.

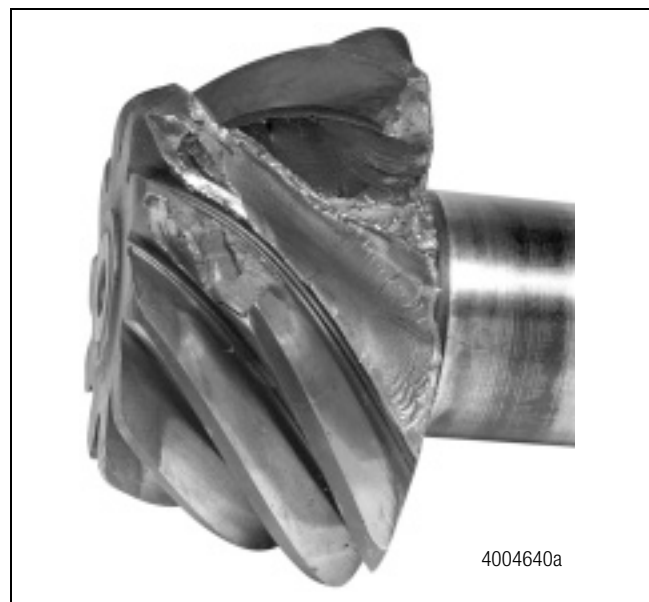

Figure 4.42

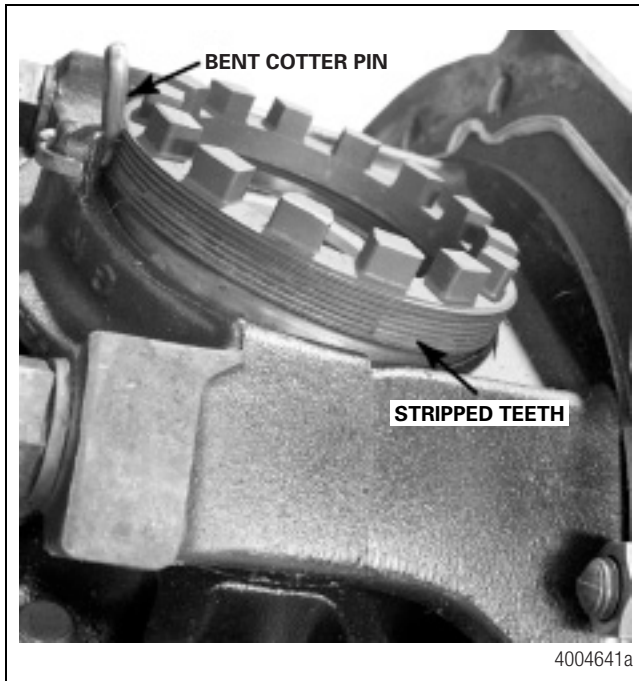

Figure 4.43

Bearing Adjusting Ring

Cause of Failure

Shock load damaged the ring gear.

What To Look For

Primary Damage: Shock load fractured three adjacent teeth, causing them to penetrate the gear mesh. Figure 4.44.

The adjusting ring pushed out of the carrier cap assembly and bent the cotter pin 90 degrees. Figure 4.45.

You can see marks on the adjusting ring where it was clamped between the main differential bearing cap and carrier case. Figure 4.46.

Prevention

Operate the vehicle within its approved application and weight limits. Teach drivers how to correctly operate a vehicle.



Figure 4.44



Figure 4.45

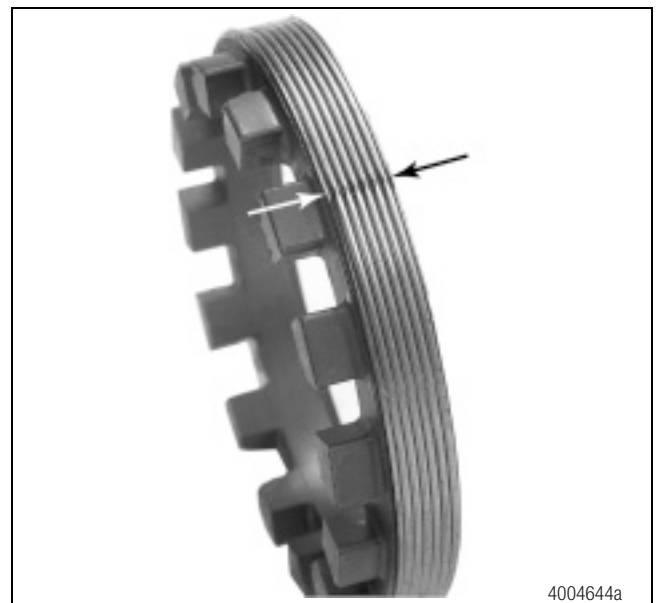

Figure 4.46

4 Drive Axles

Drive Pinion Gear

Cause of Failure

Lubricant was installed that didn't meet Meritor's specifications. As a result, metal-to-metal contact of the ring and pinion gear occurred.

What To Look For

Primary Damage: Ring gear edges are worn thin and knife-like, and the hardened tooth surfaces no longer mesh with the pinion gear. Most likely, the lubricant installed did not meet GL-5 specifications, or high operating temperatures during operation depleted extreme pressure (EP) additives. Figure 4.47 and Figure 4.48.

Indications that the correct amount of incorrect lubricant was installed: the gear set is fairly clean with little evidence of heat, you don't see any burned lube, and the lubricant contains metal particles.

Prevention

Follow Meritor's recommended maintenance practices and service procedures.



Figure 4.47



Figure 4.48

Drive Pinion Gear

Cause of Failure

Root beam fatigue damaged the drive pinion gear.

What To Look For

Primary Damage: Drive pinion teeth have fractured and broken from the pinion gear, and you see deep beach marks starting at the roots. The pinion teeth were moderately overloaded over a period of time, until a final load caused them to break from the shaft. Figure 4.49 and Figure 4.50.

Ring gear teeth are damaged. Figure 4.49.

Prevention

Operate the vehicle within its approved application and weight limits. Teach drivers how to correctly operate a vehicle.

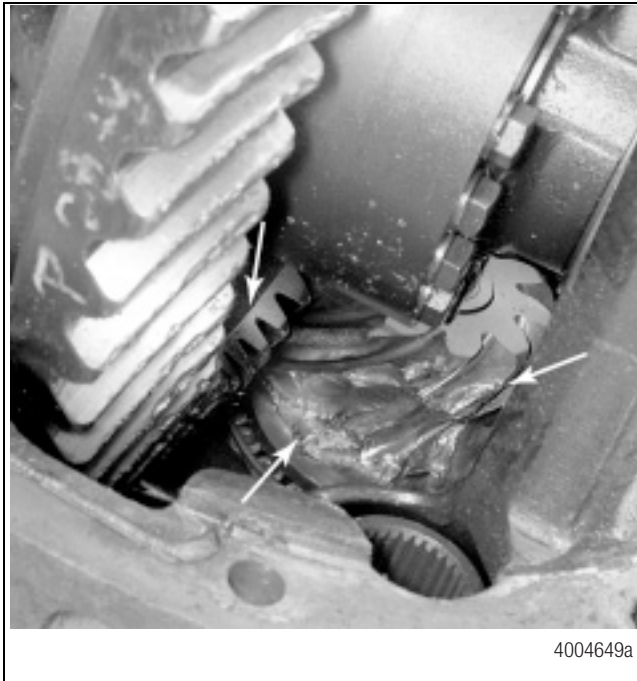

Figure 4.49

4004649a

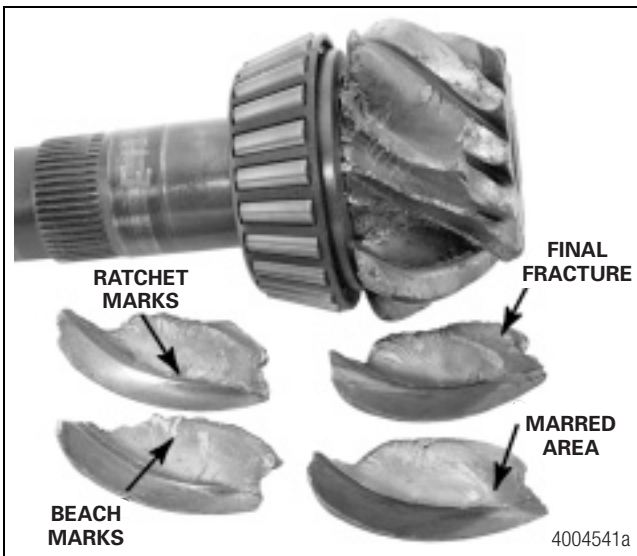

Figure 4.50

4004541a

Driver-Controlled Main Differential Lock (DCDL) Shift Collar

Cause of Failure

An operator locks the DCDL when the wheels are spinning, which causes shock load and damages the clutch collar and mating shaft splines.

What To Look For

Primary Damage: Axle shaft splines are twisted and distorted. Figure 4.51.

The DCDL collar is broken. Figure 4.52.

Prevention

Teach drivers how to correctly operate a vehicle.

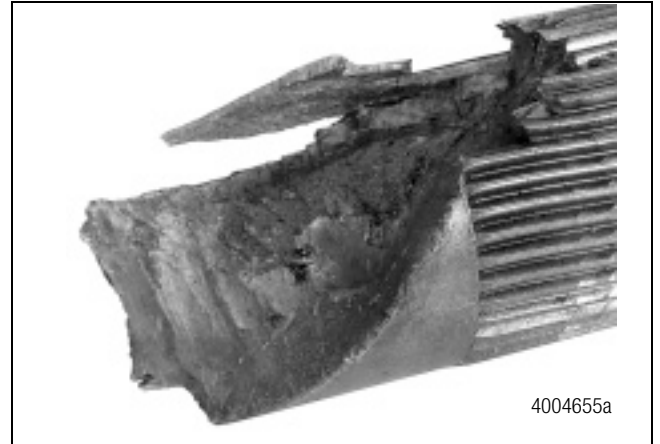

Figure 4.51

4004655a

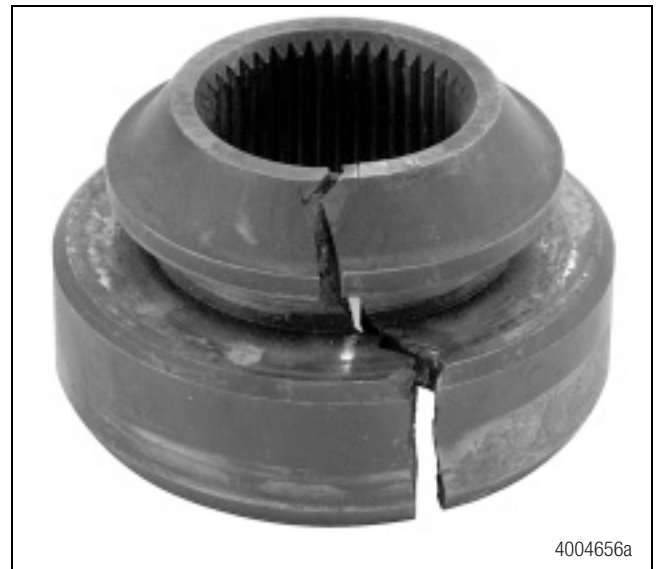

Figure 4.52

4004656a

4 Drive Axles

Driver-Controlled Main Differential Lock (DCDL) Shift Collar

Cause of Failure

An operator locked the DCDL when the wheels are spinning, which caused shock load to occur.

What To Look For

Primary Damage: The DCDL collar is broken into many pieces. Figure 4.53.

The shift fork leg is broken, and a rough, crystalline surface formed on the fracture. Figure 4.54.

Prevention

Teach drivers how to correctly operate a vehicle.

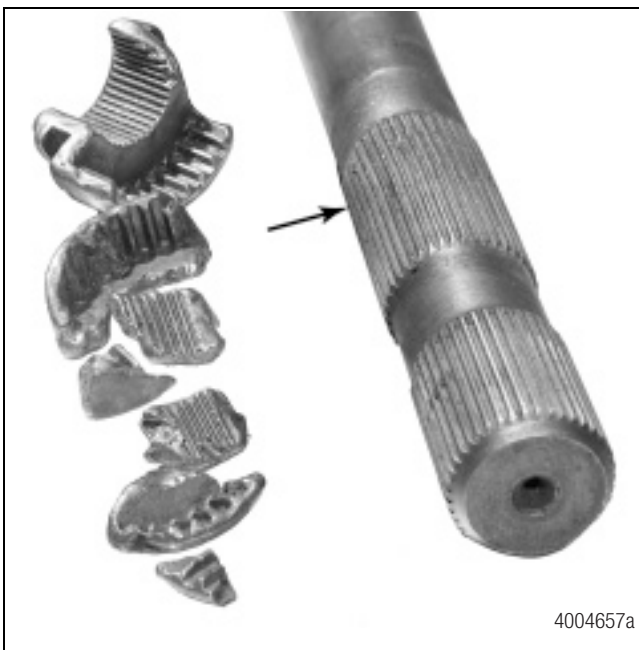

Figure 4.53

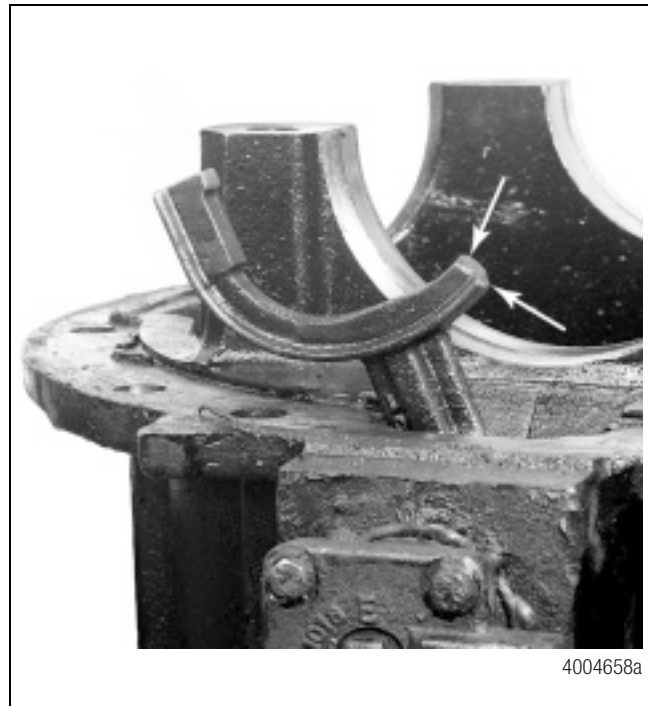

Figure 4.54

Flange-Side Main Differential Bearing

Cause of Failure

Cyclic overloading occurred. Recommended maintenance practices weren't followed.

What To Look For

Primary Damage: You find spalling on the main differential bearing rollers and race on the outer side of the rollers. Figure 4.55.

You find severe spalling on the undersurface of the drive pinion teeth. Figure 4.56.

Prevention

Operate a vehicle within its approved application and weight limits. Follow Meritor's recommended maintenance practices and service procedures.



Figure 4.55

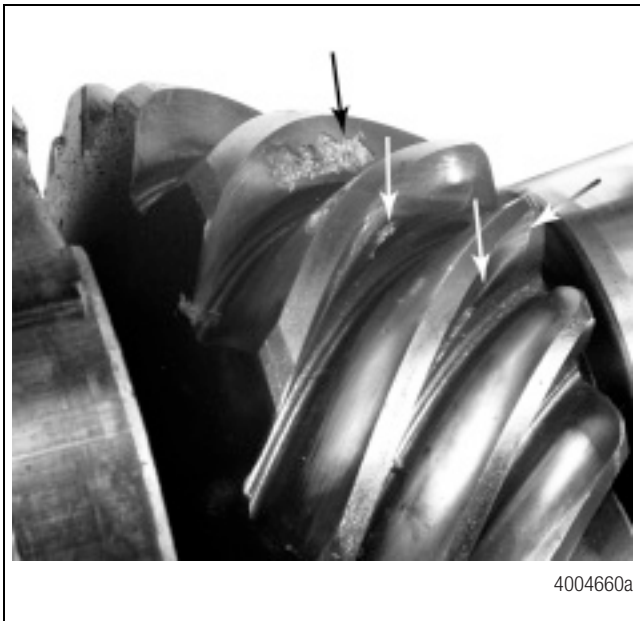

Figure 4.56

Axle Housings

Cause of Failure

The axles were loaded above specified limits for the application.

What To Look For

Primary Damage: The axle housings are fractured at the 10 o'clock position of the differential lock clearance notch. Figure 4.57.

The fractures originate at the inner rib flange, and run through the bowl weld and into the axle housing cover. Figure 4.58.

Prevention

Operate a vehicle within its approved application and weight limits.

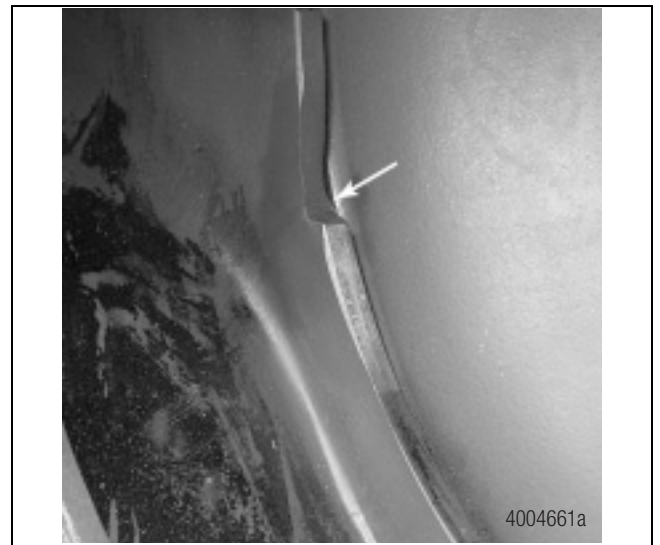

Figure 4.57

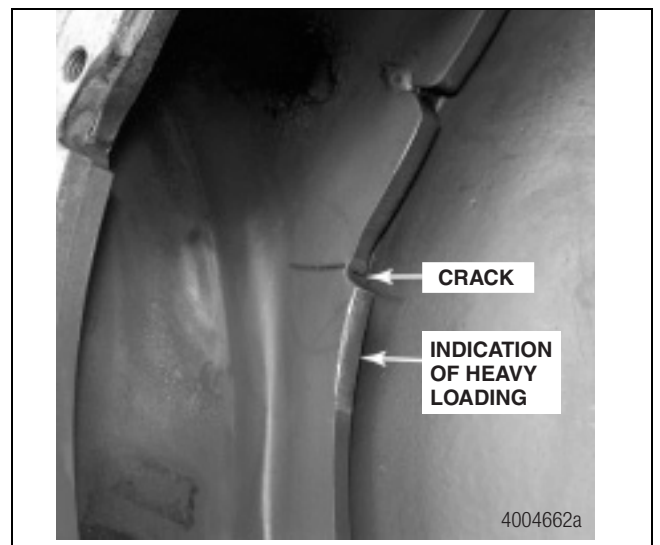

Figure 4.58

4 Drive Axles

Hypoid Ring and Drive Pinion Gears

Cause of Failure

The vehicle was operated with insufficient lubricant with depleted EP additives.

What To Look For

Primary Damage: You find crow's footing on both the ring and drive pinion gears, which indicates a low lubricant level or lubricant with depleted extreme pressure (EP) additives. The lubricant is black and has a burned odor. Figure 4.59 and Figure 4.60.

You find a large accumulation of burned lubricant on non-working surfaces.

Prevention

Follow Meritor's recommended maintenance practices and service procedures.



Figure 4.59



Figure 4.60

Inner Drive Pinion Bearing

Cause of Failure

The vehicle was operated with insufficient lubricant with depleted EP additives.

What To Look For

Primary Damage: The inner pinion cage and rollers are destroyed. Insufficient lubricant or a low lubricant level caused friction and heat buildup, which depleted EP additives. Figure 4.61 and Figure 4.62.

Lubricant on the ring gears is black with a burned odor. Figure 4.61 and Figure 4.62.

You find crow's footing on both hypoid sets, and the drive pinion gear is severely distorted. Figure 4.61 and Figure 4.62.

Prevention

Follow Meritor's recommended maintenance practices and service procedures.



Figure 4.61



Figure 4.62

Inner Drive Pinion Bearing

Cause of Failure

The vehicle was operated with insufficient lubricant.

What To Look For

Primary Damage: The inner pinion bearing cup and cone are friction-welded together. You find severe crow's footing on the hypoid set. Figure 4.63.

Lubricant on the surfaces of all interior components is black with a burned odor.

The drive pinion stem contacts the pinion cover and wears a hole into it. Figure 4.64.

Prevention

Follow Meritor's recommended maintenance practices and service procedures.



Figure 4.63

4 Drive Axles



Figure 4.64

Inter-Axle Differential (IAD)

Cause of Failure

Spinout damaged the IAD.

What To Look For

Primary Damage: In Figure 4.65, you find galling on the first IAD. On the second, you find excessive spinout damage possibly caused by mismatched tires or axle ratios.

Primary Damage: In Figure 4.66, the third IAD shows a bent spider leg, and a gear seized to another spider leg. The fourth IAD shows that the spider legs have broken from the spline collar.

Prevention

Teach drivers how to correctly operate a vehicle. Check for mismatched tires or axle ratios.



Figure 4.65



Figure 4.66

Inter-Axle Differential (IAD)

Cause of Failure

Spinout damaged the IAD.

What To Look For

Primary Damage: The drive pinions are excessively loose on the spider legs. The pinions have worn into the IAD case. Figure 4.67.

Fatigue fractured the pinion washers. Figure 4.68. Abrasive particles from spinout have caused one pinion washer to become very thin.

The lubricant is contaminated with metal or other abrasive particles.

Fatigue caused the thrust washers to fail. Figure 4.69.

Prevention

Teach drivers how to correctly operate a vehicle. Check for mismatched tires or axle ratios.



Figure 4.68

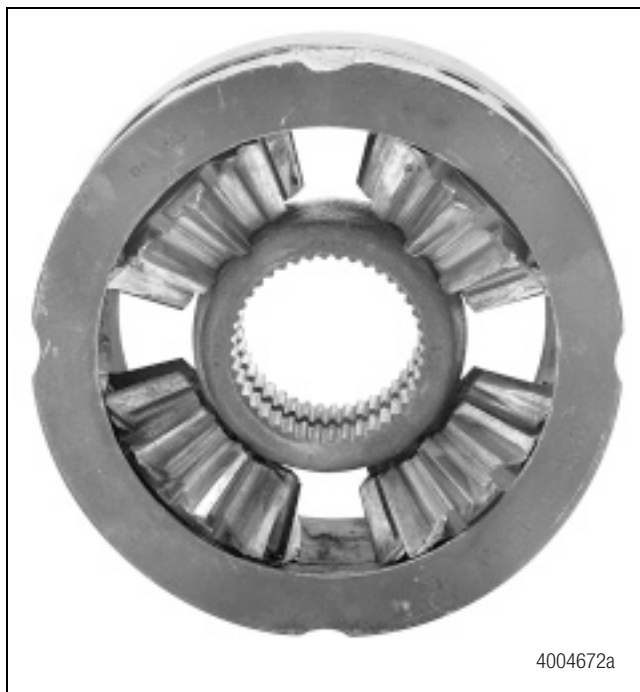

Figure 4.67



Figure 4.69

4 Drive Axles

Inter-Axle Differential (IAD)

Cause of Failure

Spinout, and possibly shock load, occurred that damaged the IAD.

What To Look For

Primary Damage: You find galling on the spider legs. Figure 4.70.

One pinion is missing from the IAD assembly. The IAD's inside walls are gouged and scuffed. There's no case separation. Figure 4.71.

Prevention

Teach drivers how to correctly operate a vehicle. Check for mismatched tires or axle ratios.



Figure 4.70



Figure 4.71

Inter-Axle Differential (IAD)

Cause of Failure

Spinout damaged the IAD spider.

What To Look For

Primary Damage: You find severe scoring on the spider legs, as well as excessive wear on three non-seized legs. Severe wear damaged one of the spider legs. Figure 4.72.

Primary Damage: You find galling, chipping and excessive wear on the pinions. One pinion spins, but won't slide off its spider leg. Figure 4.73.

Prevention

Teach drivers how to correctly operate a vehicle. Check for mismatched tires or axle ratios.



4004677a

Figure 4.72



4004678a

Figure 4.73

Inter-Axle Differential (IAD)

Cause of Failure

Spinout damaged the IAD spider.

What To Look For

Primary Damage: You find severe galling on the spider legs. Two loose spider legs have seized inside the pinions. Figure 4.74.

The four spider legs were sheared from the spider at the splined hub area. The differential case halves have separated and are broken. Figure 4.74.

Prevention

Teach drivers how to correctly operate a vehicle. Check for mismatched tires or axle ratios.



Figure 4.74

Main Differential

Cause of Failure

Spinout damaged the main differential spider.

What To Look For

Primary Damage: Several main differential spider legs have seized gears. Figure 4.75.

Primary Damage: Three legs have broken from the spider. Two gears have broken legs seized inside. Figure 4.75.

Primary Damage: One thrust washer is distorted and loose inside the main differential case. Figure 4.75. Three washers show excessive abrasive wear. Figure 4.76.

Prevention

Teach drivers how to correctly operate a vehicle. Check for mismatched tires or axle ratios.



Figure 4.75



Figure 4.76

4 Drive Axles

Flange-Side Main Differential

Cause of Failure

Contaminated lubricant was installed, or cyclic overloading occurred.

What To Look For

Primary Damage: The flange-side main differential bearing rollers are pitted and spalled. Figure 4.77.

Primary Damage: The bearing cage and rollers are missing from the flange half of the main differential case. Figure 4.77.

Primary Damage: The flange-side differential bearing inner cone is scuffed and galled. Figure 4.78.

Prevention

Follow Meritor's recommended maintenance practices and service procedures. Operate a vehicle within its approved application and weight limits.

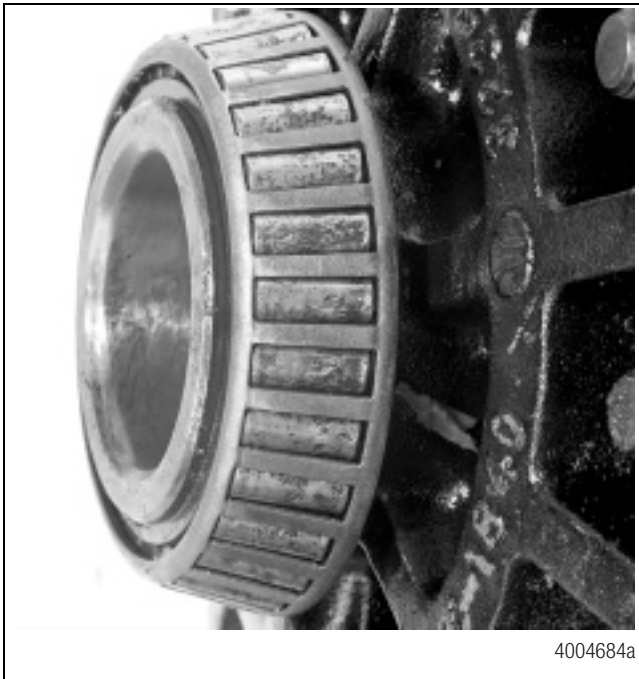

Figure 4.77



Figure 4.78

Pinion Nut

Cause of Failure

Loss of pinion bearing preload caused the gear contact pattern to shift.

What To Look For

Primary Damage: The threads on the end of the drive pinion show that the pinion nut may have lost its specified preload or was not correctly tightened during assembly procedures. It then slowly backed-off, which enabled the drive pinion shaft to move out-of-position. Figure 4.79.

Primary Damage: The drive pinion spline shows wear from a loose yoke.

Primary Damage: The drive pinion contact pattern indicates the assembly was operating out-of-position.

You find two different contact patterns on the drive pinion teeth.

The spigot bearing inner cone is on the shaft and excessively worn. The cage rollers are missing.

You find localized spalling on the inside portion of the bearing rollers and a shifting drive pinion contact pattern, which indicates that the assembly was operating out-of-position.

You find light galling at bearing contact surfaces.

Prevention

Follow Meritor's recommended maintenance practices and service procedures to correctly tighten the drive pinion nut to specification.

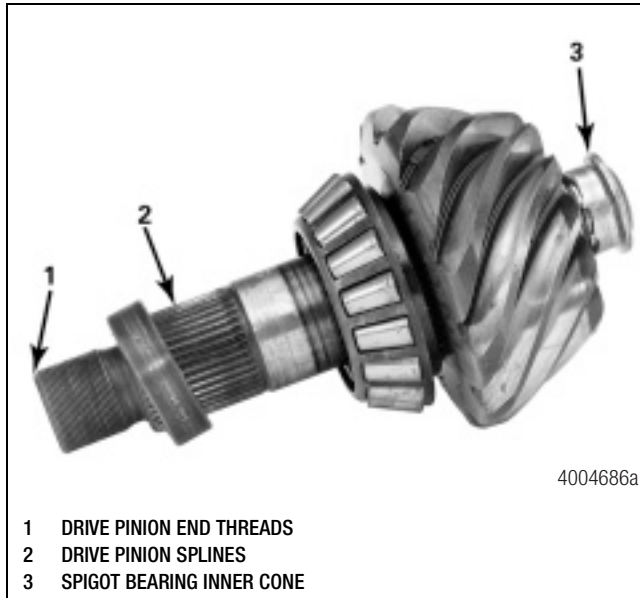

Figure 4.79



Figure 4.80

Plain-Half Differential Case

Cause of Failure

The driver-controlled main differential lock (DCDL) was used incorrectly.

What To Look For

Primary Damage: The DCDL splines have worn away. Figure 4.80 and Figure 4.81.

Prevention

Teach drivers how to correctly operate a vehicle.



Figure 4.81

4 Drive Axles

Main Differential Case-to-Case Joint Separation

Cause of Failure

Cyclic overloading occurred.

What To Look For

Primary Damage: The case-to-case bolts were broken by bending fatigue, which was caused by a forward-reverse motion in the driveline related to heavy loading and rough surface applications. Figure 4.82.

You find galling between the bolt holes at the main differential case joint. Notches on the main differential case halves and bolt holes are often deformed or “walled out” from wear to the inside diameter. Figure 4.83.

Prevention

Operate a vehicle within its approved application.

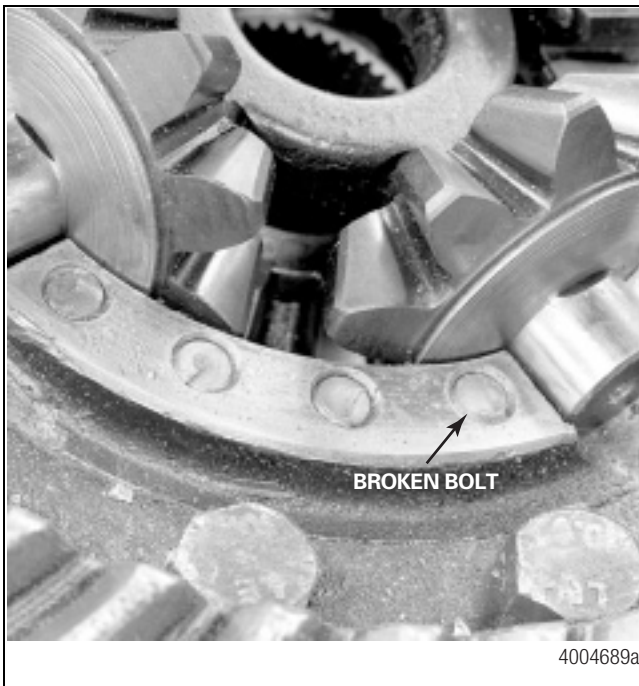

Figure 4.82



Figure 4.83

Pump System Screens

Cause of Failure

The lubricant was contaminated, or the vehicle was insufficiently lubricated.

What To Look For

Screen 1 is in normal condition. Figure 4.84.

Screen 2 is severely contaminated with burned lubricant that includes some silicone gasket material, dirt and particles. When the screen was removed from the carrier, the lubricant was black and sludge-like, which could affect the oil pump. Figure 4.84.

Screen 3 is filled with metal chips and particles. Figure 4.85.

Prevention

Follow Meritor’s recommended maintenance practices and service procedures.

It’s also important to note that when you apply silicone gasket material, the bead must not exceed 0.125-inch (3 mm), or you can block lubrication passages and damage components.

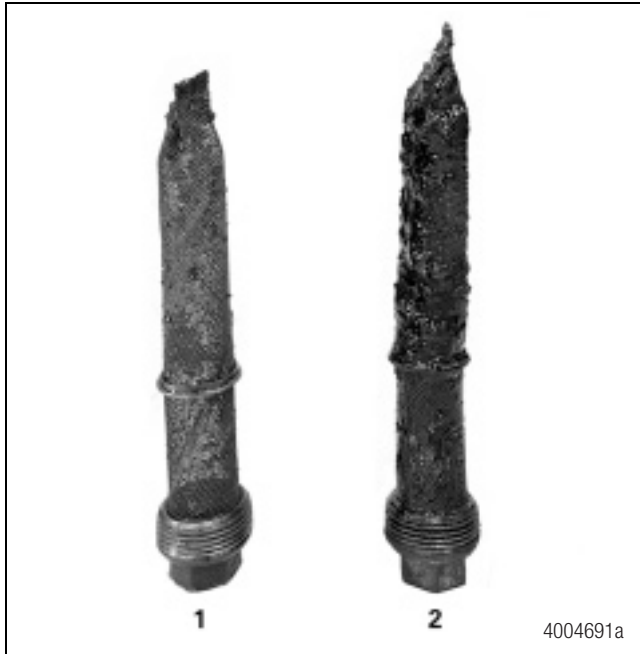

Figure 4.84



Figure 4.85

Rear Side Gear

Cause of Failure

Torsional vibration damaged the rear side gear.

What To Look For

Primary Damage: You find excessive wear on the rear side gear bevel teeth. Figure 4.86.

The IAD pinion teeth are excessively worn. Figure 4.87.

Prevention

Inspect the driveline. Check that working angles and phasing are correct. Check that suspension air ride height is correct.



Figure 4.86

4 Drive Axles



Figure 4.87

Ring Gear

Cause of Failure

Cyclic overloading occurred, or the vehicle was operated under severe conditions.

What To Look For

Primary Damage: The ring gear fractured into many pieces, which indicates severe operating conditions and vehicle overloading. There's also evidence that an engine retarder overloaded the coast side of the ring gear teeth during downhill braking. Figure 4.88.

You find a distinct tooth contact pattern change on the drive pinion.

All ring gear teeth show fatigue fractures that originate on the coast side of the tooth roots. Figure 4.89.

Prevention

Operate a vehicle within its approved application and weight limits.



Figure 4.88

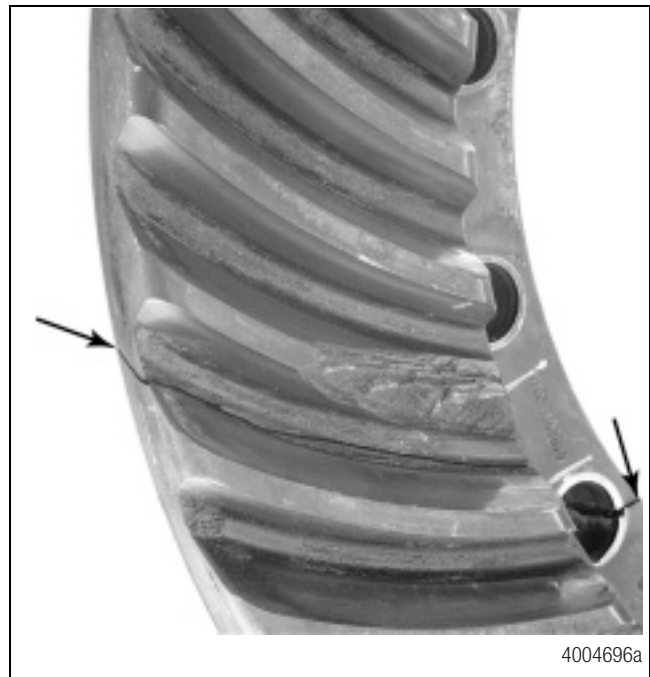

Figure 4.89

Ring Gear

Cause of Failure

Root beam fatigue or cyclic overloading occurred.

What To Look For

Primary Damage: The ring gear fractured into many pieces, which indicates severe operating conditions and overloading. There's evidence that an engine retarder, used for downhill braking, overloaded the coast side of the ring gear teeth. This is confirmed by the heavy thrust-screw contact that occurred. Figure 4.90 and Figure 4.91.

Primary Damage: You find heavy spalling on the main differential bearing components. Figure 4.92.

The flange of the differential case half separated. Figure 4.93.

The gear-to-case bolts were loose. This condition isn't related to the gear failure, because the fracture doesn't originate at the bolt hole, but at the root of the teeth.

You find heavy thrust screw contact on the backside of the ring gear.

Prevention

Operate a vehicle within its approved application and weight limits.

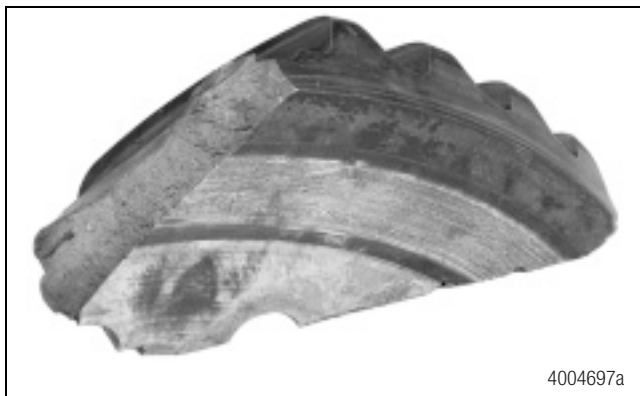

Figure 4.90

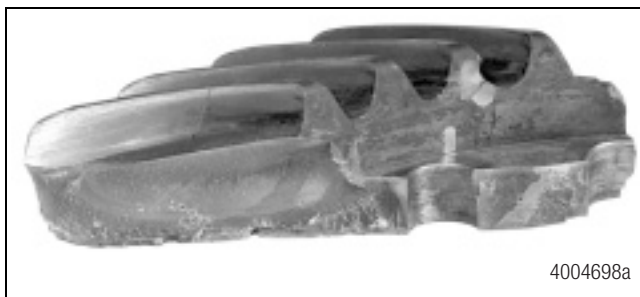

Figure 4.91

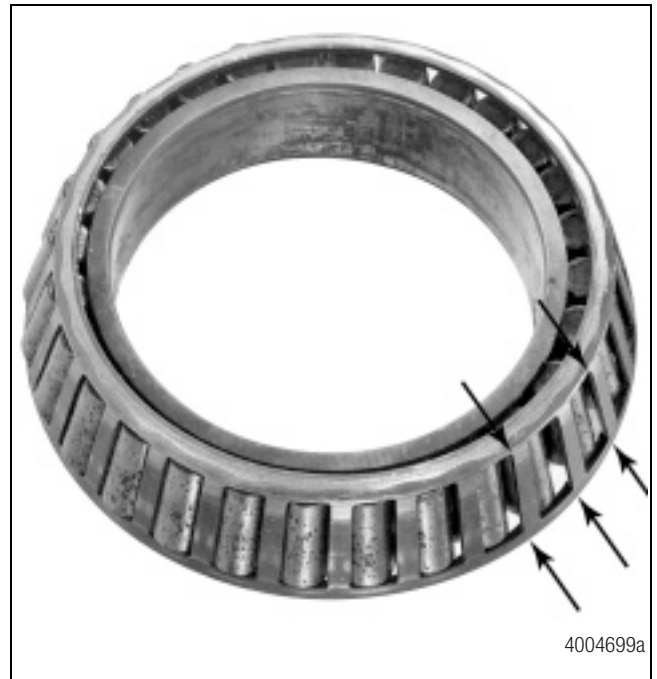

Figure 4.92

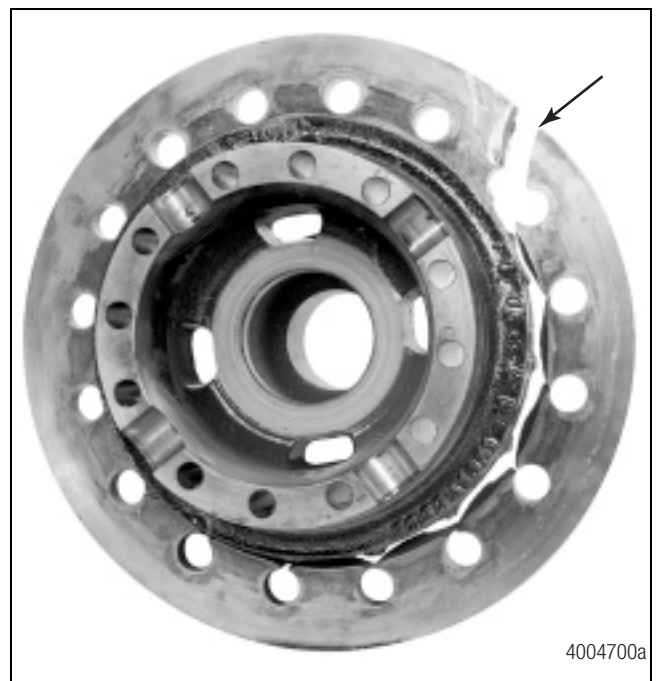

Figure 4.93

4 Drive Axles

Side Gears

Cause of Failure

Most likely, shock load occurred when the vehicle's spinning wheel hit dry pavement.

What To Look For

Primary Damage: A tooth broke from the main differential and side gear. Several other teeth are cracked.

Primary Damage: The side gear teeth next to the broken tooth are cracked at the base. Figure 4.94.

Primary Damage: A rough, crystalline finish formed on both teeth at the fractures. Figure 4.94.

Carrier noise was reported.

Prevention

Teach drivers how to correctly operate a vehicle.



Figure 4.94

Axle Shaft and Differential Side Gear Spline

Cause of Failure

The sliding fit that is required in the axle shaft-to-differential side gear splined coupling allows for a small amount of angular misalignment of the two components before hard contact occurs at the spline ends.

Overload conditions cause angular misalignment at the axle shaft-to-side gear spline interface. As the load on the axle housing continues to increase, the angular misalignment becomes more severe, axle deflection occurs, and the increased contact pressure in the differential side gear spline results in rapid wear.

What To Look For

Primary Damage: Premature wear at the axle shaft-to-differential side gear interface caused by unusually heavy contact at the spline ends. Figure 4.95.

Prevention

Operate a vehicle within its approved application and weight limits. Follow recommended maintenance practices.

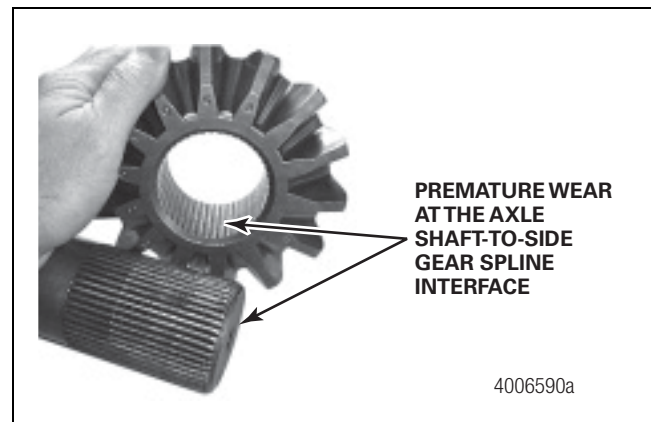

Figure 4.95

Side Gear Thrust Washer

Cause of Failure

Spinout damaged the side gear thrust washer.

What To Look For

Primary Damage: The thrust washer seized onto the side gear. Figure 4.96. You find burned lubricant and galling areas on the thrust washer.

Prevention

Teach drivers how to correctly operate a vehicle.



Figure 4.96

Thrust Washers

Cause of Failure

Spinout damaged the thrust washer.

What To Look For

Primary Damage: One leg broke from the spider and seized within the pinion gear journal. Figure 4.97.

Primary Damage: You find excessive wear and galling on all four spider legs. Figure 4.98.

The thrust washers are worn. Figure 4.98.

Prevention

Teach drivers how to correctly operate a vehicle.



Figure 4.97



Figure 4.98

Oil Seals

If you notice moisture, wetness or oil drips on or around an axle oil seal, it's important to recognize if the seal is leaking, or if it only appears to be leaking.

How to Recognize a Leaking Seal

Inspect the oil seal and surrounding area for wetness. If the seal and area appear very wet or visibly drip oil, or if you notice oil dripping from the bottom of the output seal retainer, replace the seal.

Inspect the yoke for wetness. Check for a leak path leading to the rear lip of the seal. If you notice wetness around the yoke hub or a leak path leading to the rear lip of the seal, replace the seal.

4 Drive Axles

How to Recognize a Seal That Appears to be Leaking

Seals come prelubricated with grease that melts at low temperatures under normal operating conditions. Melted grease can moisten or wet the area between the lip of the oil seal. When this happens, you won't find a leak path leading to the seal. If you notice a moist seal and don't find a leak path, do not replace the seal.

A seal can also become moist from lubricants applied to the yoke or retainer bolts during assembly. When this happens, you won't find a leak path leading to the seal. If you notice a moist seal and don't find a leak path, do not replace the seal.

Seal Test Procedure

1. Thoroughly clean and dry the area around the entire seal retainer casting, especially at the top.
2. Drive the vehicle for 15-20 minutes at highway speeds.
3. Check for wetness or moisture on or around the seal. Also check for oil dripping from the seal. If you notice either of these conditions, replace the seal.

Example 1: The Seal is not Leaking

Cause of Failure

None

What To Look For

The area around the seal is dry. There's no evidence of displaced packing grease or a leak path. Figure 4.99 and Figure 4.100.

Prevention

Follow Meritor's recommended maintenance practices and service procedures.

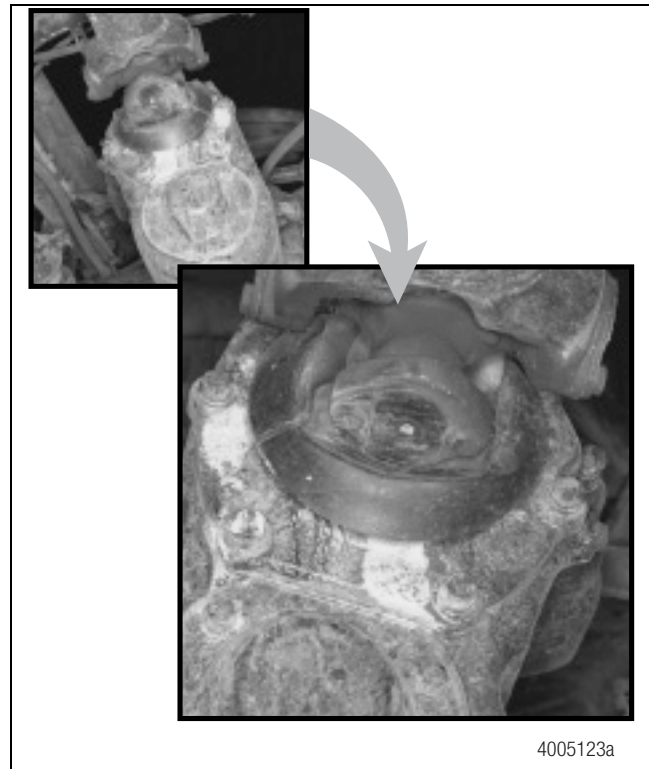

Figure 4.99

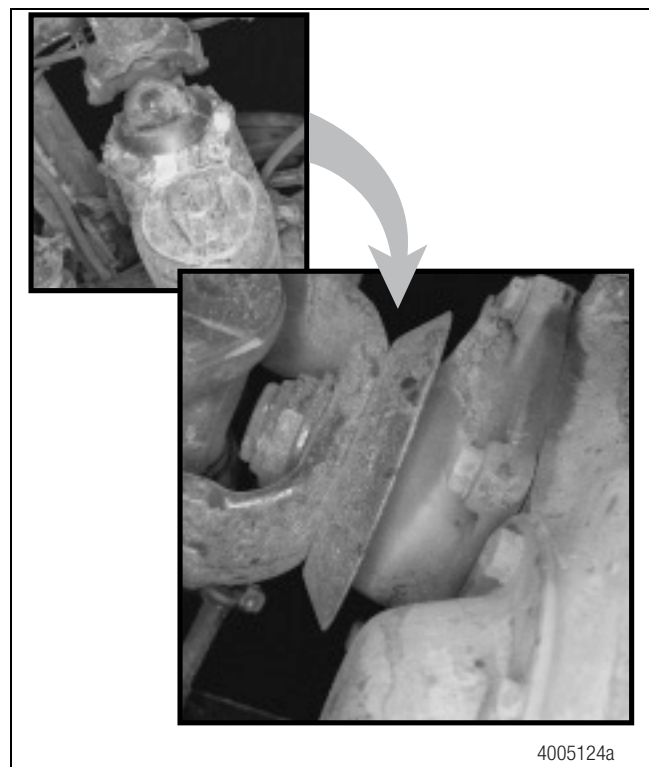

Figure 4.100

Example 2: The Seal Appears to be Leaking

Cause of Failure

A failure is possible. Inspect the seal. If a failure has occurred, determine its cause.

What To Look For

Seals are prelubricated with packing grease that melts at low temperatures during normal operating conditions. In Figure 4.101, you'll see the melted grease at the forward output through-shaft area.

Check the lubricant level. If it's low, replace the seal. If not, monitor the seal for leaks.

Prevention

Follow Meritor's recommended maintenance practices and service procedures.

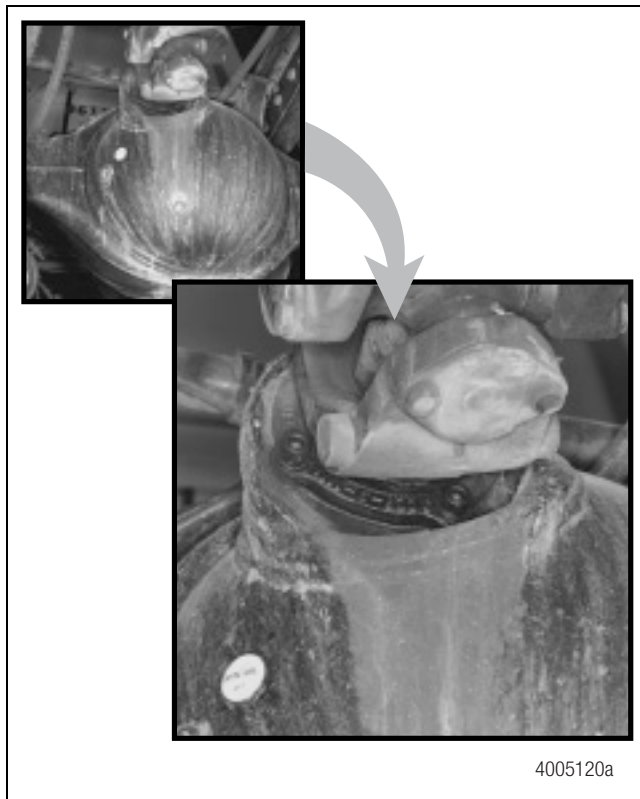

4005120a

Figure 4.101

Example 3: The Seal is Leaking

Cause of Failure

Most likely, dirt or contaminants have entered the seal, or the seal's service life is expended.

What To Look For

Inspect the oil seal and surrounding area for wetness. If the seal and area appear very wet or visibly drip oil, or if you notice oil dripping from the bottom of the output seal retainer, the seal requires replacement.

Inspect the yoke for wetness. Check for a leak path leading to the rear lip of the seal. If you notice wetness around the yoke hub or a leak path leading to the rear lip of the seal, replace the seal. Figure 4.102, Figure 4.103 and Figure 4.104.

Prevention

Follow Meritor's recommended maintenance practices and service procedures.

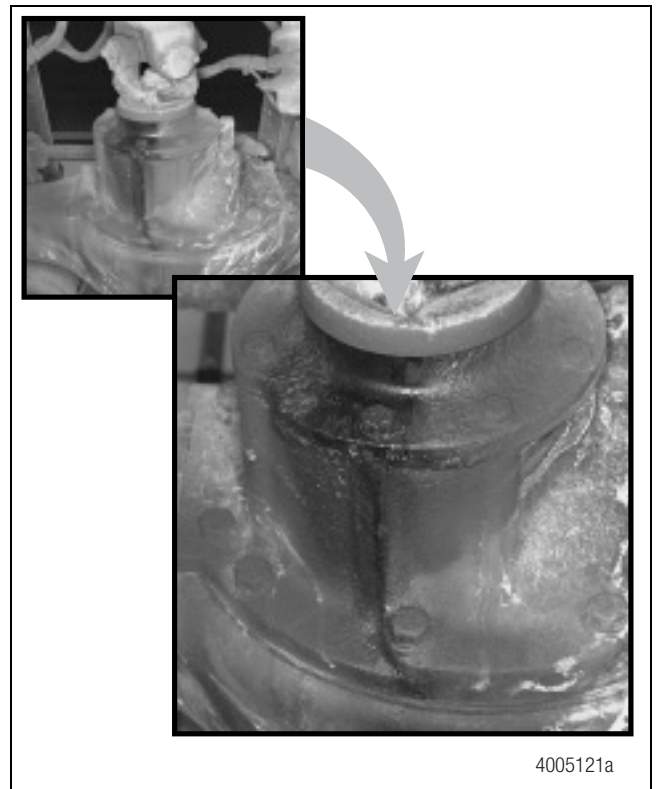

4005121a

Figure 4.102

4 Drive Axles



Figure 4.103

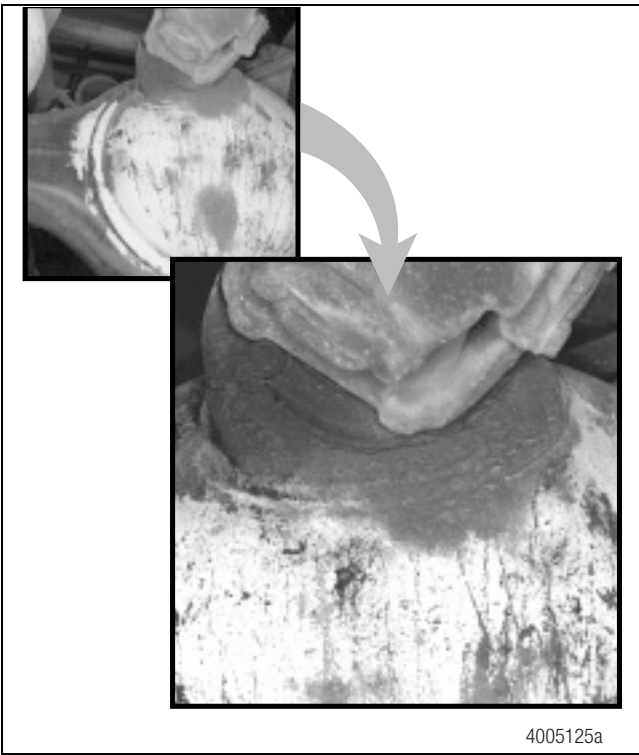

Figure 4.104

Parts Analysis Overview

Evaluate Damaged Driveline Components

⚠ WARNING

Wear safe eye protection to prevent serious eye injury when you inspect heavy vehicle components.

This section provides a parts analysis process to help you determine why driveline components failed during operation, what to look for when you inspect the parts, and how to help prevent failures from occurring again.

Most of the time, you can find the answers you need by visually inspecting a failed component. Sometimes, however, this process may require specialized knowledge or equipment.

Why a product fails can be difficult to determine, and a failure can vary in appearance from vehicle to vehicle. Failures in models from the same manufacturer can also vary, so it's important to use the information presented here as a guide, not a rule, when you perform parts analysis inspections.

Driveline Components

A typical driveline consists of yokes, tubing, universal joints — and in some cases, a center bearing. Slip yokes enable a driveline to change in length, and u-joints enable it to operate at a variety of angles. Figure 5.1. Tubing transmits turning torque from one u-joint to another, and the center bearing provides support for longer drivelines.

The main causes of driveline failure during operation are shock load, torsional vibration and lubricant issues.

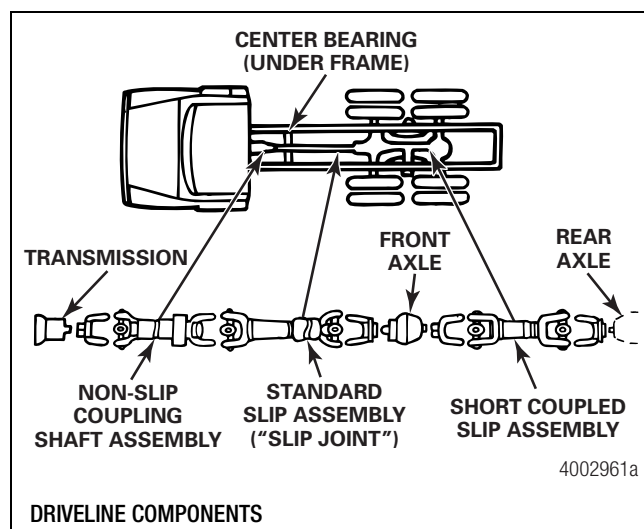

Figure 5.1

U-Joint

Cause of Failure

Shock load applied a sudden and powerful force to the u-joint, which caused it to fail. For example, the operator backed under a trailer with excessive force, or the vehicle's spinning wheel hit dry pavement.

What To Look For

A rough, crystalline surface has formed on the u-joint at the fracture point. Figure 5.2.

Prevention

Teach drivers how to correctly operate a vehicle.

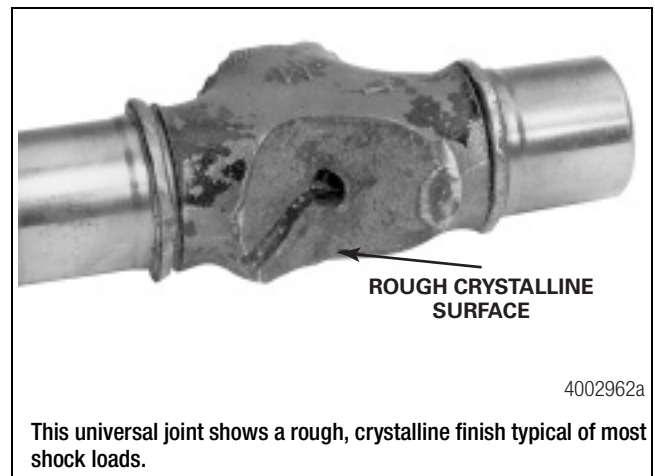

This universal joint shows a rough, crystalline finish typical of most shock loads.

Figure 5.2

U-Joint

Cause of Failure

The u-joint failed because it wasn't maintained according to Meritor's maintenance practices and intervals. Galling, a type of surface fatigue, can also occur when two unlubricated metal surfaces rub against each other. Galling is also called "metal transfer."

What To Look For

Heat and friction caused by insufficient lubricant, or installing an incorrect lubricant, caused a u-joint to wear through the side of its bearing cap. A u-joint requires a high-quality extreme pressure (EP) lubricant. Figure 5.3.

5 Drivelines

Prevention

Operate a vehicle within its approved application and weight limits. Follow Meritor's recommended maintenance practices and service procedures.

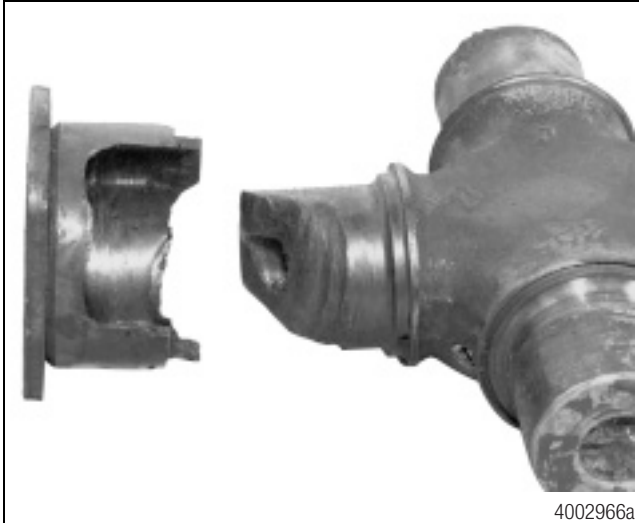

This universal joint shows the damage that can happen from lack of lubricant. The friction and heat created by the lack of lubricant caused the universal joint trunnion to wear through the side of its roller bearing cap.

Figure 5.3

Drive Shaft Tube

Cause of Failure

Figure 5.4 shows that shock load occurred on a drive shaft tube.

What To Look For

You'll see that the tube is twisted and bent, but didn't fracture or separate from other components, which is the usual result of shock load. The drive shaft tube is the only driveline component that's affected this way by shock load.

Prevention

Teach drivers how to correctly operate a vehicle.

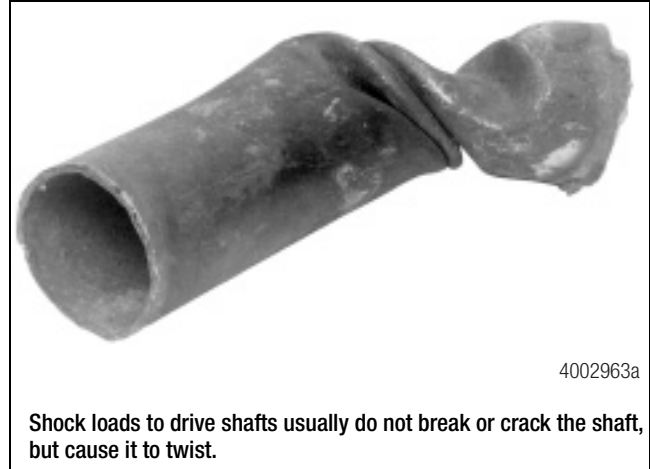

Shock loads to drive shafts usually do not break or crack the shaft, but cause it to twist.

Figure 5.4

Yokes

Cause of Failure

Instantaneous shock load applied a sudden and powerful force to the yoke, which caused it to fracture and fail. For example, instantaneous shock load occurs when an operator backs under a trailer with excessive force, or when a vehicle's spinning wheel hits dry pavement.

What To Look For

The yoke fracture is a "clean break," and a rough crystalline surface has formed at the fracture point. Figure 5.5 and Figure 5.6.

Prevention

Teach drivers how to correctly operate a vehicle.

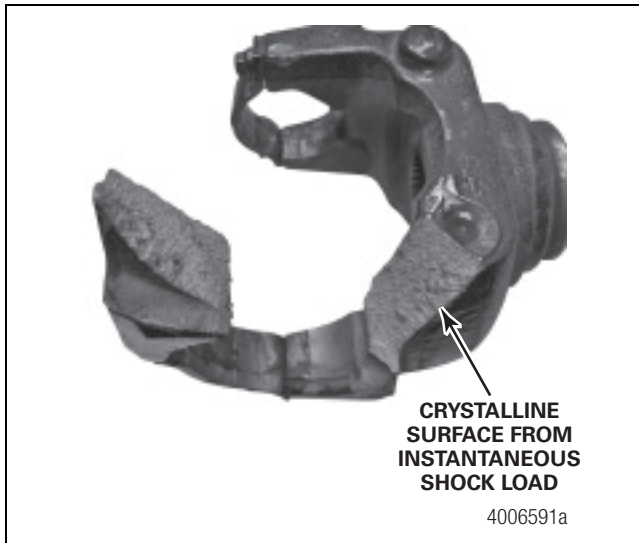

Figure 5.5

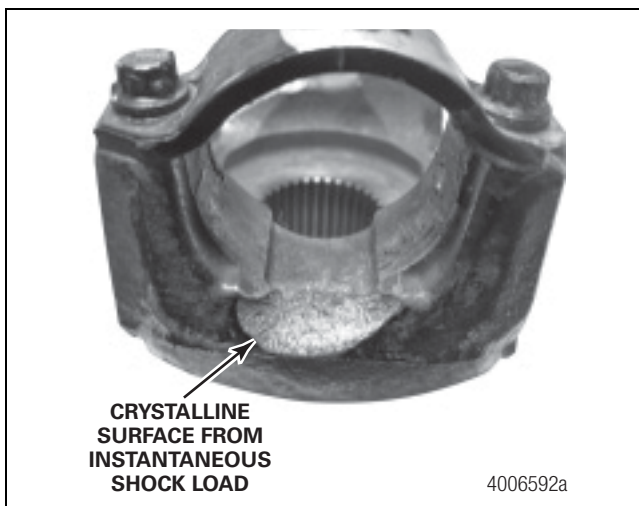

Figure 5.6

U-Joint Trunnion

Cause of Failure

Spalling, a type of wear fatigue that breaks the surface of the components into chips or fragments, caused the u-joint to fail.

When the metal surface of a component breaks into chips or fragments as a result of wear fatigue, the condition is called "spalling." Spalling is a type of surface fatigue and is evident in the advanced stages of pitting, which is the beginning of surface fatigue. You can usually find spalling on u-joint trunnions that are opposite each other. Starting as small pitted areas, spalling can progress rapidly.

What To Look For

Figure 5.7 shows the effects of spalling on a u-joint trunnion that most likely occurred from cyclic overloading. The surface of the u-joint has broken into chips or fragments.

Prevention

Operate a vehicle within its approved application and weight limits. Follow recommended maintenance practices.



Figure 5.7

U-Joint Trunnion

Cause of Failure

Brinelling, which is a type of surface fatigue, caused the needle rollers to wear deep grooves into the trunnion surface, and in some cases, the bearing cap.

What To Look For

This roller bearing shows the effects of brinelling, which causes the needle rollers to wear grooves into the surface of the trunnion. Figure 5.8.

To determine if the condition you see is brinelling, check the trunnion with your fingertip. Do you feel deep grooves? If so, brinelling has occurred.

Prevention

Operate a vehicle within its approved application and weight limits. Follow recommended maintenance practices.

5 Drivelines



Figure 5.8

Splined Shaft

Cause of Failure

Torsional fatigue caused excessive twisting that weakened the splined shaft and caused it to fail.

What To Look For

Torsional fatigue has damaged the splined shaft in Figure 5.9. The fracture started at the base of each spline. As the splines continued to weaken, the metal formed a star-shaped, radial pattern, which eventually broke the shaft at the center.

Prevention

Operate a vehicle within its approved application and weight limits. Follow Meritor's recommended maintenance practices and service procedures.

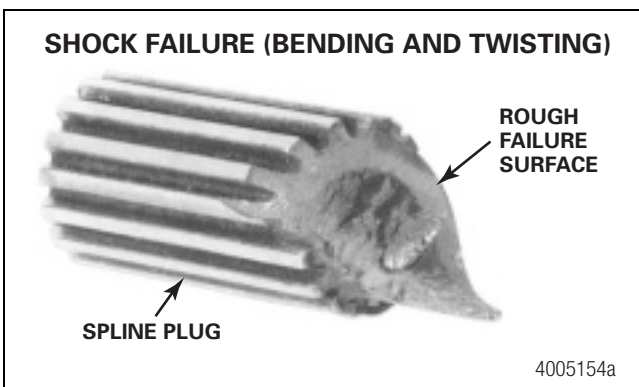

Figure 5.9

Parts Analysis Overview

Evaluate Damaged Trailer Axle Components

⚠️ WARNING

Wear safe eye protection to prevent serious eye injury when you inspect heavy vehicle components.

This section provides a parts analysis process to help you determine why trailer axle components failed during operation, what to look for when you inspect the parts, and how to help prevent failures from occurring again.

Most of the time, you can find the answers you need by visually inspecting a failed component. Sometimes, however, this process may require specialized knowledge or equipment.

Why a product fails can be difficult to determine, and a failure can vary in appearance from vehicle to vehicle. Failures in models from the same manufacturer can also vary, so it's important to use the information presented here as a guide, not a rule, when you perform parts analysis inspections.

Main Causes of Trailer Axle Failure

Shock load, torsional fatigue, bending fatigue and incorrect welds are the main causes of trailer axle failure.

Shock load can cause a trailer axle to fail immediately, or it will fracture the axle, which usually depends on how fast the trailer's moving and the weight it's hauling. If a fracture occurs, the axle will continue to operate and fail at a later time. For example, if a trailer is overloaded and hits a large pothole, shock load will occur.

Meritor trailer axles are available in a variety of sizes and configurations, and are designed and rated for specific load applications. Figure 6.1. The gross axle weight rating (GAWR) specifies the maximum load limit for a trailer. Trailer axles that are operated above their GAWR can be damaged by torsional fatigue and bending fatigue.

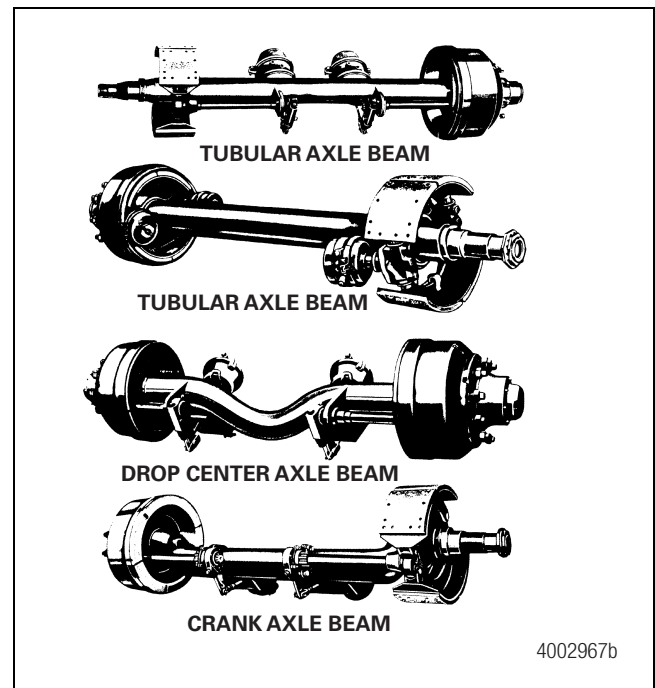

Figure 6.1

Trailer Axle

Cause of Failure

The camshaft bracket was welded incorrectly to the trailer axle.

What To Look For

Welding on an axle creates intense heat that changes the characteristics of the metal that surrounds the weld, and an incorrect weld can cause fatigue to occur. In Figure 6.2, fatigue had created a stress riser, which caused the axle to fail.

Prevention

Axle weld locations and welding procedures must adhere to Meritor standards and guidelines. Refer to Maintenance Manual 14, Trailer Axles, for complete welding instructions. To obtain this publication, refer to the Service Notes page on the front inside cover of this manual.

6 Trailer Axles

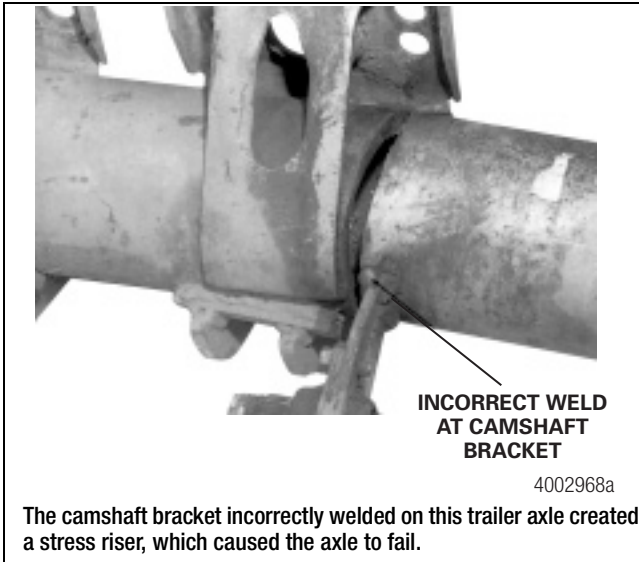

Figure 6.2

Trailer Axle

Cause of Failure

Bending fatigue occurred, which was caused by an overloaded trailer axle. Under normal loads, a trailer axle will flex slightly as it's loaded and unloaded. However, if the axle's overloaded and a stress riser is present, beam resistance is reduced, the axle flexes too much, and bending fatigue occurs.

What To Look For

Usually, bending fatigue failures are toward the outer edges of the trailer axle. Figure 6.3 shows beach marks that begin at the initial fracture point and then move away from it.

Prevention

Operate the vehicle within its approved application and weight limits.

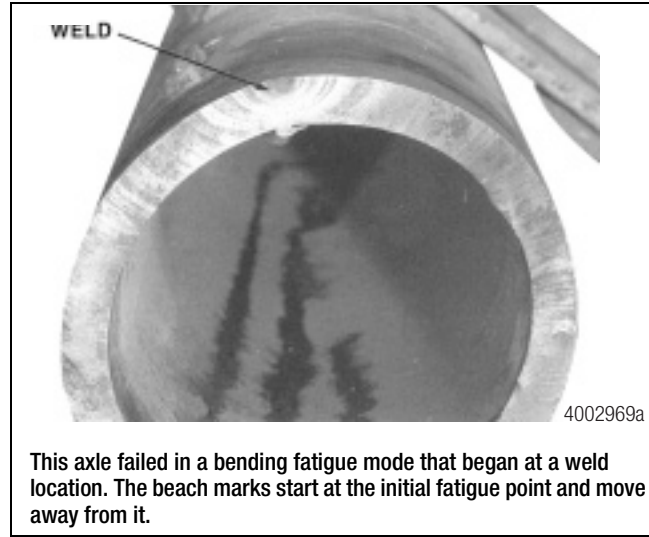

Figure 6.3

Trailer Axle

Cause of Failure

Torsional fatigue twisted the axle, which can occur when certain suspensions apply excessive loads to axle welds.

What To Look For

Beach marks begin at the initial fracture point and then move away from it. When torsional fatigue weakens the axle, the fracture often extends at a 45-degree angle to the axle's centerline. Fractures often form as an "S" or "Z" shape. Figure 6.4.

Prevention

Operate the vehicle within its approved application and weight limits.

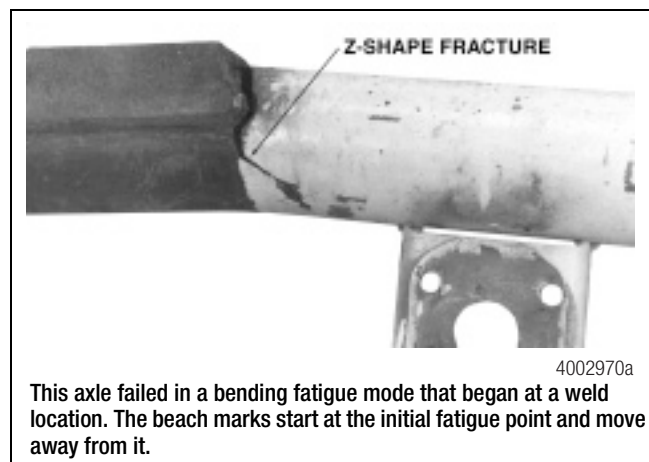

Figure 6.4

Trailer Axle

Cause of Failure

Shock load applied a sudden and powerful force to the trailer axle. Shock load can destroy or damage a component immediately. Often, however, a component damaged by shock load will continue to operate, but it will wear prematurely or fail soon after the initial shock load has occurred.

What To Look For

Figure 6.5 shows a trailer axle that was bent by shock load. The axle didn't fail immediately, but flexed too much and didn't return to its original shape as it continued to operate. When a trailer axle is damaged this way, the bend usually occurs outside the suspension mounts. A bent axle can affect tire wear and how the trailer handles, and must be replaced.

A bent trailer axle is not the same as a trailer axle damaged by bending fatigue.

Prevention

Operate the vehicle within its approved application and weight limits.

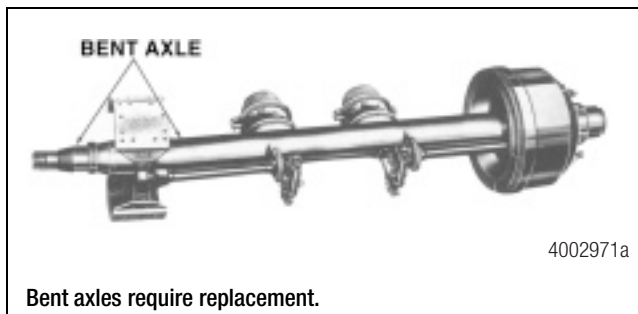

Figure 6.5

7 Automatic Slack Adjusters

Parts Analysis Overview

Evaluate Damaged Automatic Slack Adjusters

⚠ WARNING

Wear safe eye protection to prevent serious eye injury when you inspect heavy vehicle components.

This section provides a parts analysis process to help you determine why automatic slack adjusters failed during operation, what to look for when you inspect the parts, and how to help prevent failures from occurring again.

Most of the time, you can find the answers you need by visually inspecting a failed component. Sometimes, however, this process may require specialized knowledge or equipment.

Why a product fails can be difficult to determine, and a failure can vary in appearance from vehicle to vehicle. Failures in models from the same manufacturer can also vary, so it's important to use the information presented here as a guide, not a rule, when you perform parts analysis inspections.

Automatic Slack Adjuster

A slack adjuster is vital to correct brake operation. As linings wear, Meritor's automatic slack adjusters automatically adjust clearance between the brake lining, and brake drum or rotor on cam and air disc brakes. Figure 7.1.

If a slack adjuster is installed at an incorrect angle, the brakes will either have too much clearance, or the brakes will drag. Too much clearance will decrease braking efficiency and cause brakes to be out-of-balance.

The main causes of automatic slack adjuster failure during operation are incorrect installation, maintenance and rebuild practices.

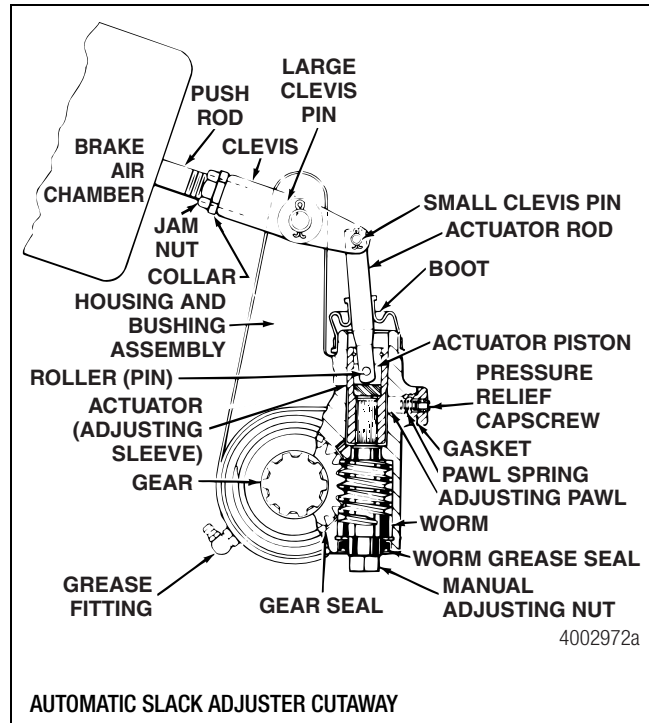

Figure 7.1

Pawl Teeth

Cause of Failure

The pawl teeth are damaged.

What To Look For

Figure 7.2 shows damage to pawl teeth that occurs when the adjusting nut is turned in the incorrect direction.

Prevention

Follow Meritor's recommended maintenance practices and service procedures.

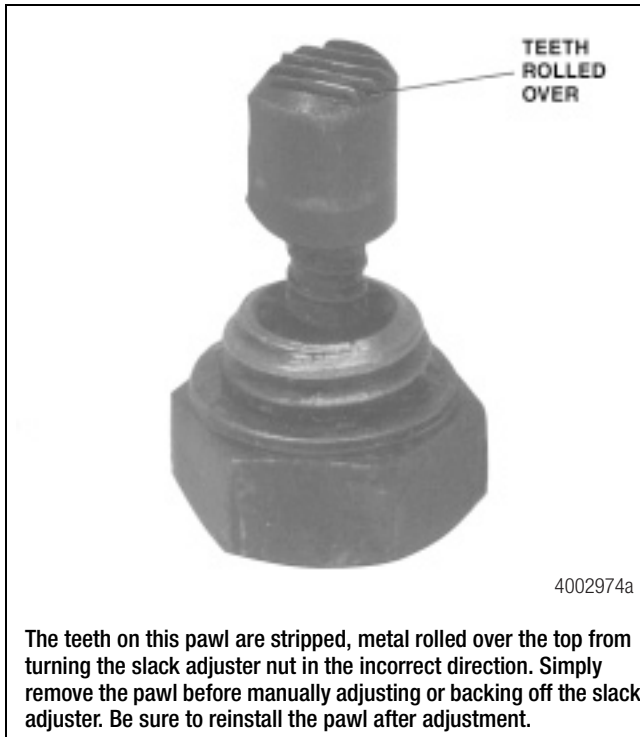

Figure 7.2

Automatic Slack Adjuster

Cause of Failure

The slack adjuster was insufficiently lubricated, the lubricant was contaminated, or the incorrect lubricant was installed into the slack adjuster.

What To Look For

Insufficient lubrication can cause internal friction, difficulty turning the adjusting nut, and loss of automatic adjustment. If grease is pumped into the fitting at a pressure that's too high, it will push the boot off the slack adjuster or rip the rubber boot. Both of these situations will contaminate the grease. Figure 7.3.

Prevention

Follow Meritor's recommended maintenance practices and service procedures.

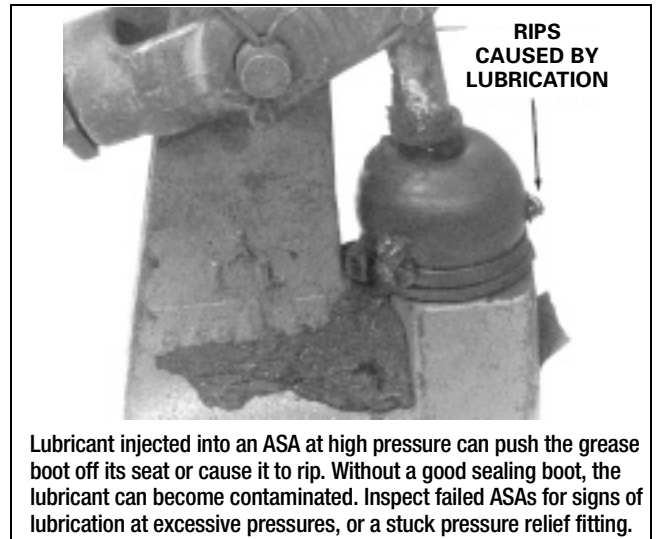

Figure 7.3

Automatic Slack Adjuster and Camshaft Splines

Cause of Failure

The slack adjuster was not correctly lubricated.

What To Look For

Figure 7.4 shows slack adjuster and camshaft splines that have corroded from insufficient lubricant.

Prevention

Follow Meritor's recommended maintenance practices and service procedures.

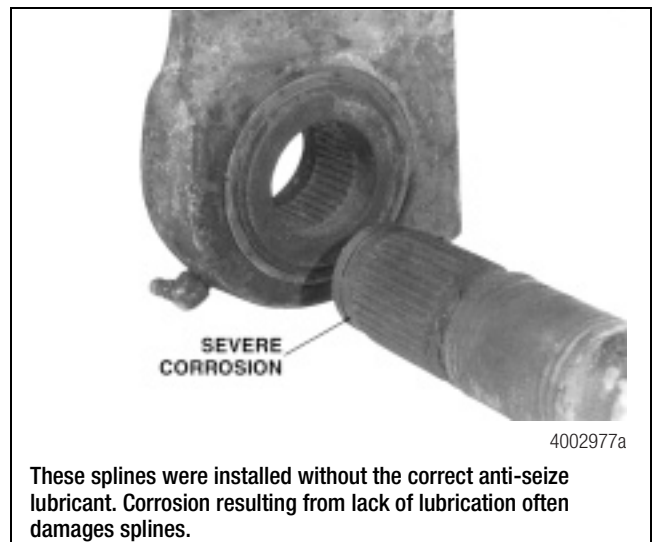

Figure 7.4

8 Cam and Air Disc Brakes

Parts Analysis Overview

Evaluate Damaged Brake Components

⚠ WARNING

Wear safe eye protection to prevent serious eye injury when you inspect heavy vehicle components.

This section provides a parts analysis process to help you determine why brake components failed during operation, what to look for when you inspect the parts, and how to help prevent failures from occurring again.

Most of the time, you can find the answers you need by visually inspecting a failed component. Sometimes, however, this process may require specialized knowledge or equipment.

Why a product fails can be difficult to determine, and a failure can vary in appearance from vehicle to vehicle. Failures in models from the same manufacturer can also vary, so it's important to use the information presented here as a guide, not a rule, when you perform parts analysis inspections.

Main Causes of Cam and Air Disc Brake Component Failures

Table C

Cause	Cam and Air Disc Brakes	Air Disc Brakes Only
Incorrect slack adjuster angles	✓	
Spring brake didn't fully release	✓	
Excessive wear	✓	
Air system problems	✓	
High operating temperatures	✓	
Lubricant issues		✓
Deep scoring on the rotor		✓
Paint or corrosion on caliper slide pins		✓

Cam and Air Disc Brakes

Cause of Failure

Automatic slack adjuster angles are not correct.

What To Look For

A slack adjuster is vital to correct brake operation. As linings wear, Meritor's automatic slack adjusters automatically adjust clearance between the brake lining, and brake drum or rotor on cam and air disc brakes.

If a slack adjuster is installed at an incorrect angle, the brakes will either have too much clearance, or the brakes will drag. Too much clearance will decrease braking efficiency and cause brakes to be out-of-balance. Figure 8.1.

Prevention

Follow service procedures and install the correct slack adjuster for the brake type to prevent over-adjustment and excessive brake clearance. Figure 8.2.

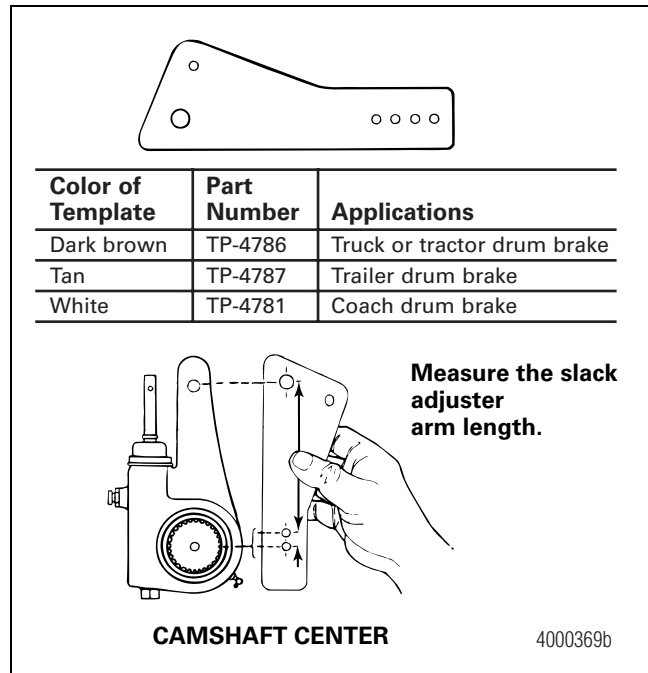

Figure 8.1

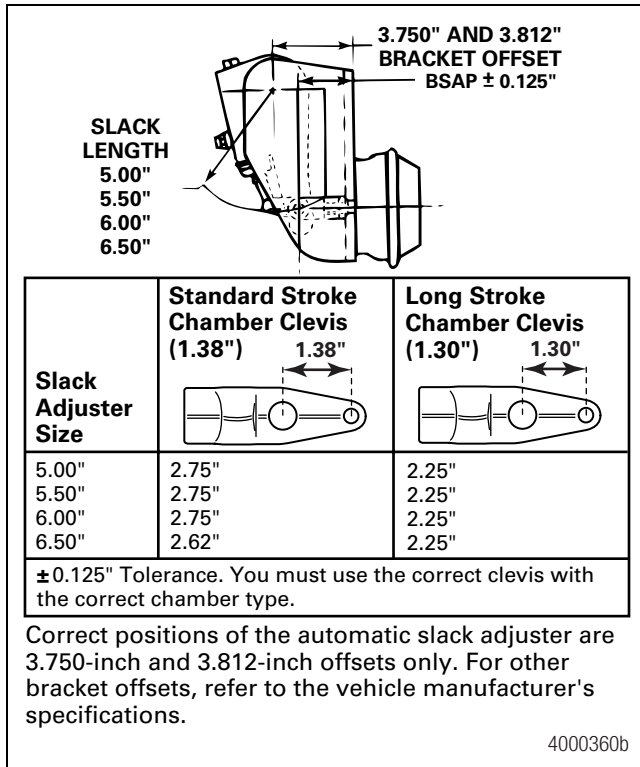

Figure 8.2

Cam and Air Disc Brakes

Cause of Failure

The spring brake didn't fully release.

The spring brake applies braking force when the air system is drained, and it's also used as a parking brake when the vehicle is stationary. During operation, air pressure releases the spring brake to move the vehicle, and the service brake half of the air chamber controls braking. Figure 8.3.

What To Look For

If the spring brake fails to fully release, the brakes will drag and the linings will wear prematurely. Look for damage caused by excessive heat buildup. Check for mechanical problems with the spring brake and problems in the air system. Figure 8.4.

Prevention

Follow Meritor's recommended maintenance practices and service procedures.

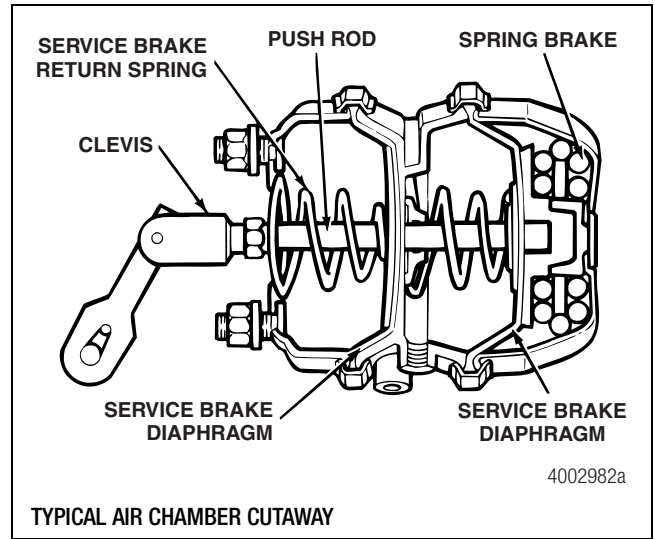

Figure 8.3

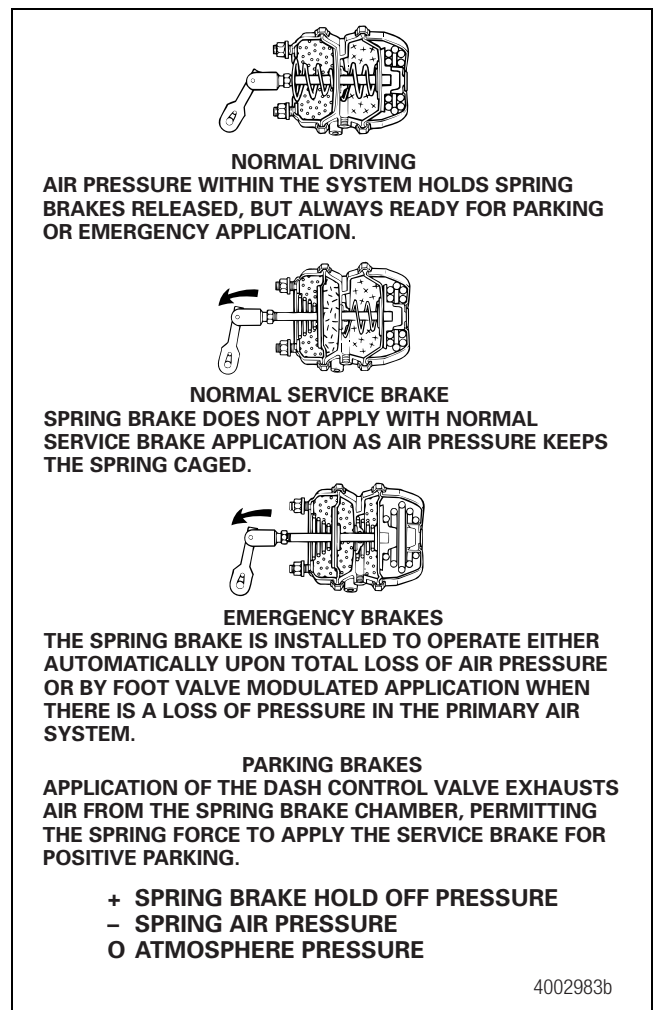

Figure 8.4

8 Cam and Air Disc Brakes

Cam and Air Disc Brakes

Cause of Failure

Corroded or plugged air system valves prevented some brakes from operating correctly, causing brake imbalance.

The air system supplies the force to apply and release the brakes. Figure 8.4. If air valves stick because they're corroded or plugged with contaminants, the brakes may not apply, or they'll apply with too much force. For example, if a valve malfunctions, the parking brakes and service brakes can apply at the same time and damage components. This is called "compounding."

Also, incorrect crack-pressure settings on relay valves in the tractor and trailer cause one half of the vehicle to brake most often, or all of the time; while the other half does little or no braking. This imbalance between the tractor and trailer can result in increased brake temperature and premature lining wear.

What To Look For

Figure 8.5 shows a brake drum with deep scores and heat checks caused by an air system problem that kept the air chamber partially charged when the trailer brake wasn't applied. As a result, the cam didn't fully release, and brake drag occurred during operation.

Prevention

Bleed the system's wet tank daily to help prevent moisture buildup that corrodes the air valves. Follow Meritor's recommended maintenance practices and service procedures.

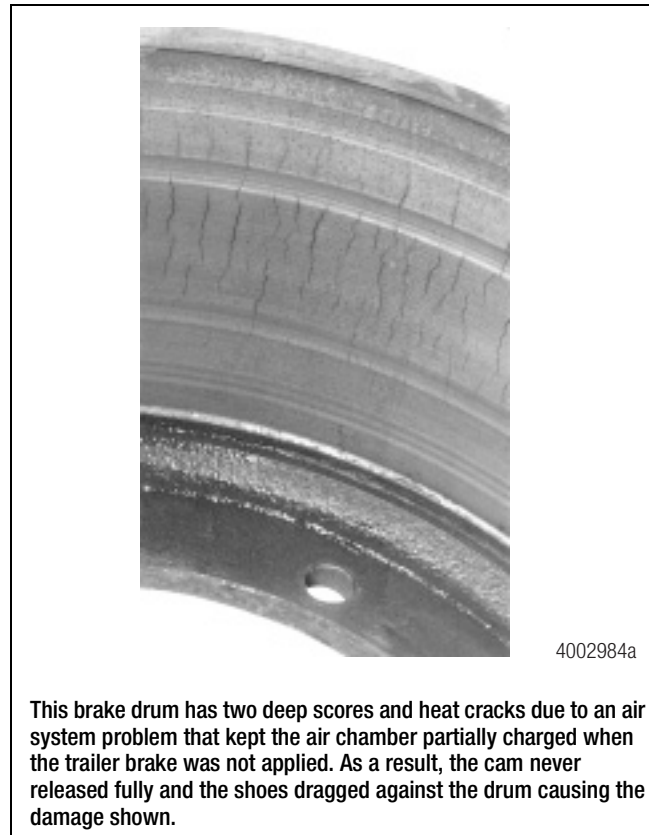

Figure 8.5

Cam and Air Disc Brakes

Cause of Failure

Excessive wear can occur when a vehicle is overloaded, or when linings drag against the drum or rotor when the brakes should be released.

What To Look For

Figure 8.6 shows metal-to-metal contact damage to the rotor when excessive wear from brake drag removed the linings from the pads.

Prevention

Operate a vehicle within its approved application and weight limits.

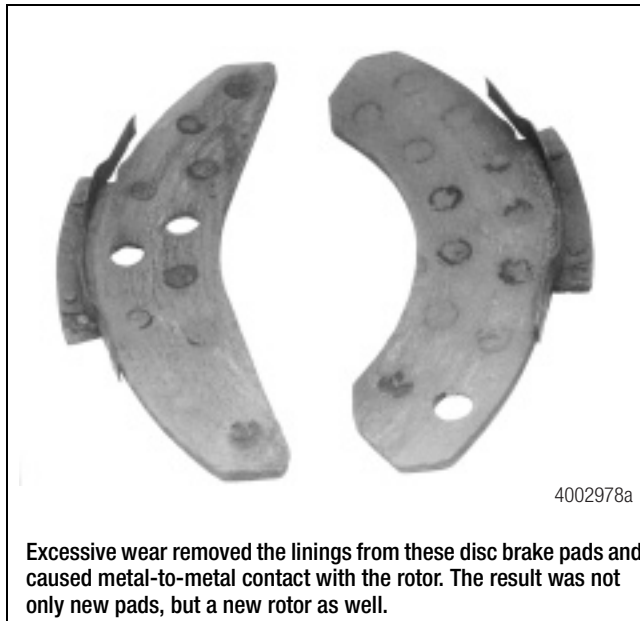

Figure 8.6

Cam and Air Disc Brakes

Cause of Failure

High operating temperatures damaged the brake components.

High operating temperature is one of the main causes of premature lining wear. Some reasons why high operating temperatures occur: The brakes are imbalanced, applied often, or they drag against the drum. Premature wear accelerates as operating temperatures increase.

High operating temperatures will eventually cause brake components — usually the linings, drums and rotors — to warp or fracture. Figure 8.7 shows a brake rotor damaged by scoring and heat cracks that were caused by an air system that wasn't functioning correctly.

What To Look For

Figure 8.8 shows a brake pad with heat checks on the entire friction surface that resulted from high operating temperatures.

Prevention

Operate a vehicle within its approved application and weight limits.

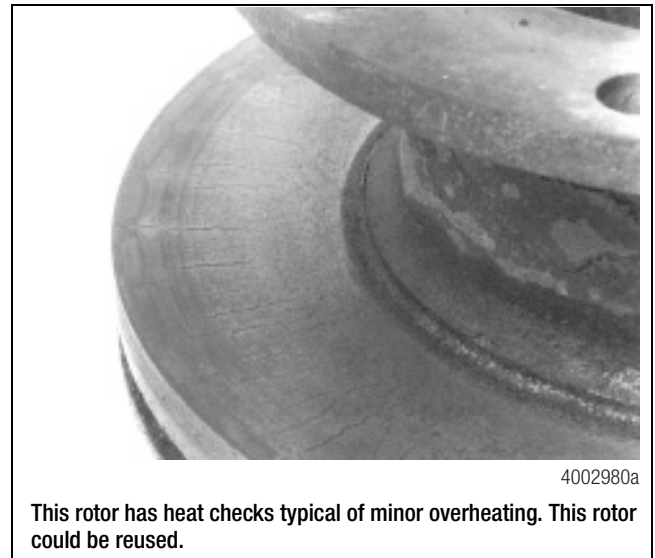

Figure 8.7

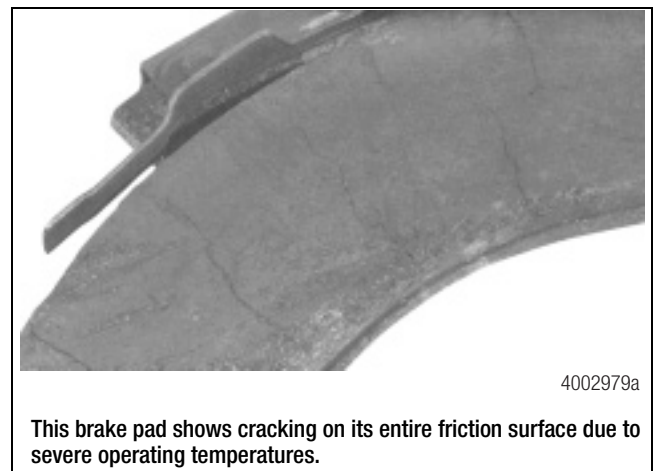

Figure 8.8

8 Cam and Air Disc Brakes

Air Disc Brakes Only

Cause of Failure

Heavy heat checking damaged the rotor surface.

There are two types of heat checking: light and heavy. Figure 8.9.

What To Look For

Heavy heat checking is surface cracks that are wide and deep. You must replace the rotor if heat checks have a width of more than 0.02-inch (0.5 mm), a depth of more than 0.04-inch (1 mm), and extend radially across the surface more than 75%. Figure 8.10.

Light heat checks are fine lines or cracks on a rotor's surface, a normal condition that results when the rotor's friction surface continually heats and cools. A rotor with light heat checking doesn't need replacement. Figure 8.11 and Figure 8.12.

Prevention

Follow Meritor's recommended maintenance practices and service procedures.

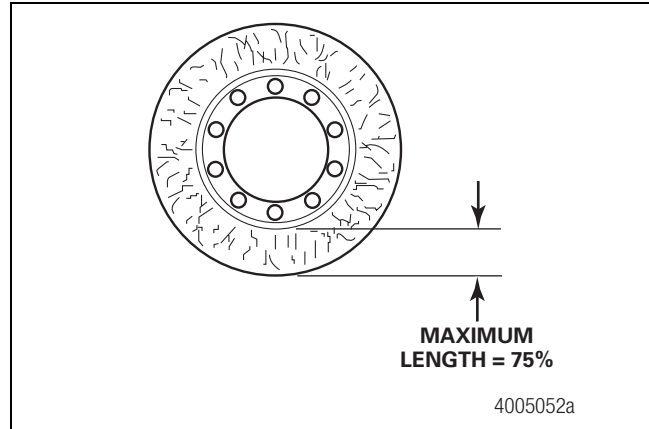

Figure 8.10

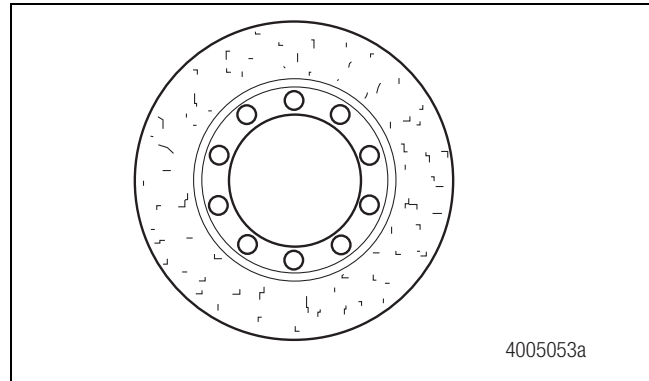

Figure 8.11

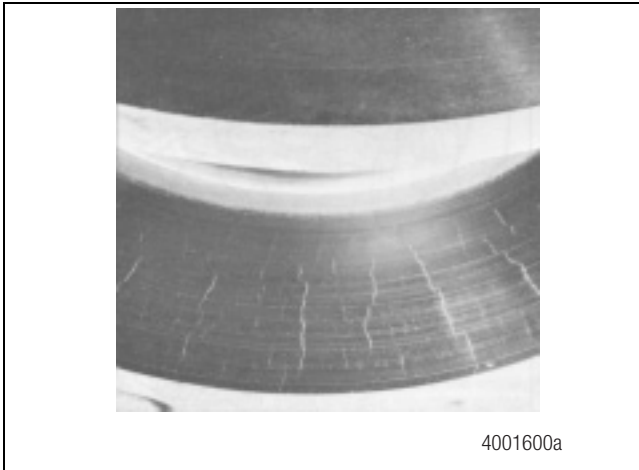

Figure 8.9

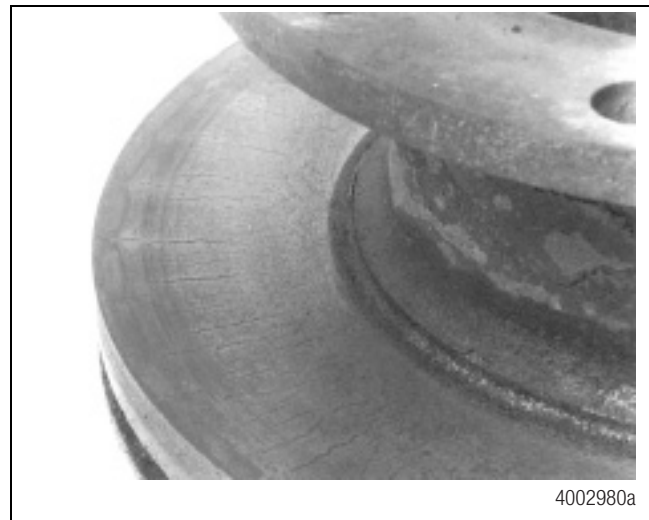

Figure 8.12

Air Disc Brakes Only

Cause of Failure

The rotor is has deep grooves or scores.

What To Look For

Inspect both sides of the rotor. If you find grooves or scores of a depth less than 0.02-inch (0.5 mm), continue to use the rotor. If the grooves are greater than 0.02-inch (0.5 mm), you may choose to resurface the rotor. If the rotor thickness measured across any groove is less than 1.46-inches (37 mm), discard and replace the rotor. Figure 8.13.

Prevention

Follow Meritor's recommended maintenance practices and service procedures.

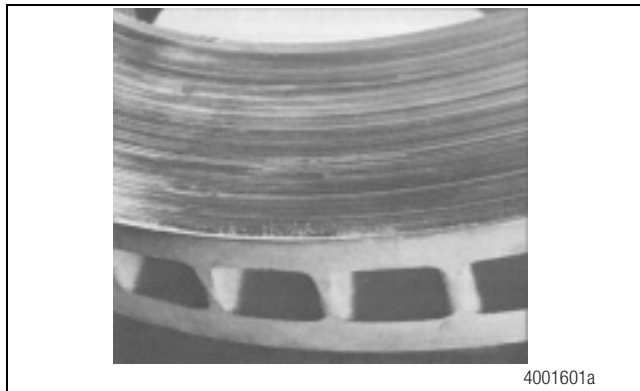

Figure 8.13

4001601a

Model ADB 1560 Air Disc Brake Only

Cause of Failure

There's paint or corrosion on the caliper slide pins.

What To Look For

Slide pins enable the caliper assembly to apply braking pressure on both sides of the rotor. If the slide pins are painted, the caliper can corrode and seize, and only the inboard pad will apply pressure. As a result, the inboard pad wears prematurely. Figure 8.14.

When a caliper assembly is insufficiently lubricated, the slide pins will corrode and cause the brake pads to drag on the rotor. If a caliper assembly is over-lubricated, pressure will build up and prevent the brake pads from retracting. Figure 8.14.

Prevention

Follow Meritor's recommended maintenance practices and service procedures.

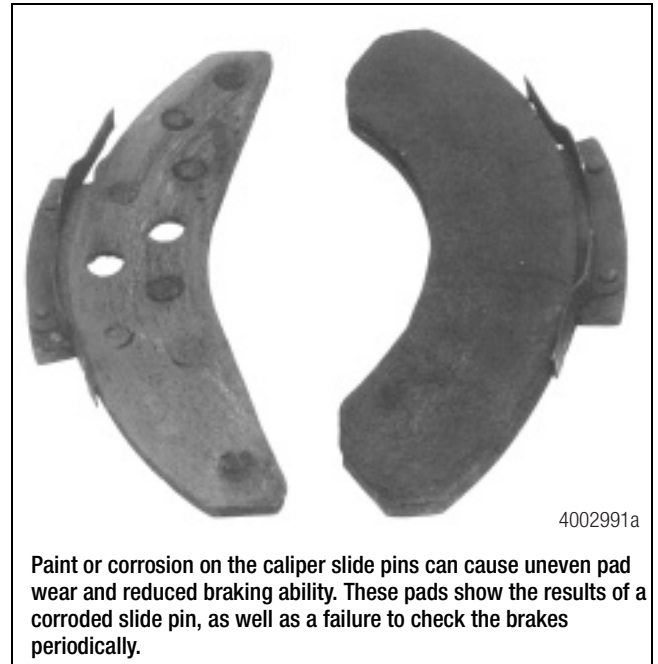

4002991a

Paint or corrosion on the caliper slide pins can cause uneven pad wear and reduced braking ability. These pads show the results of a corroded slide pin, as well as a failure to check the brakes periodically.

Figure 8.14

Brake Drums

Normal Wear

Brake drums wear evenly under normal operating conditions. Use fleet history, if available, to determine the approximate wear rate of tractor drums. Normal wear is the usual reason that a brake drum's removed from service.

Deep, Uniform Wear

Deep, uniform wear at the edge of the drum where the lining path begins can result from brake drag, imbalance, contaminants embedded in the brake lining, no brake retarder, braking with a hand valve, not downshifting on steep grades, and exceeding a vehicle's braking capacity. Figure 8.15 and Figure 8.16.

Replace the drum. Install dust shields; or if they're installed, remove the shields and operate the vehicle.

8 Cam and Air Disc Brakes

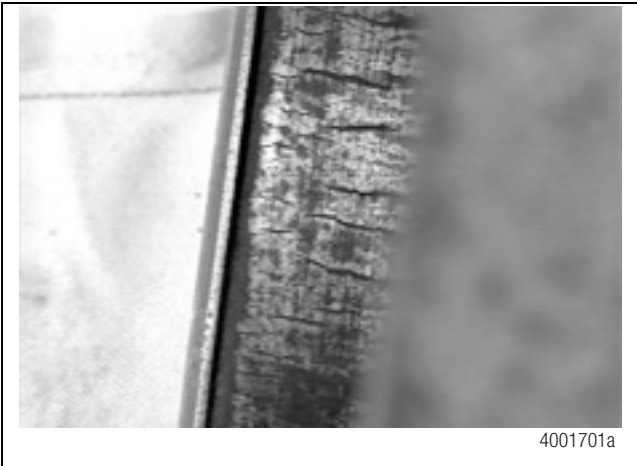

Figure 8.15

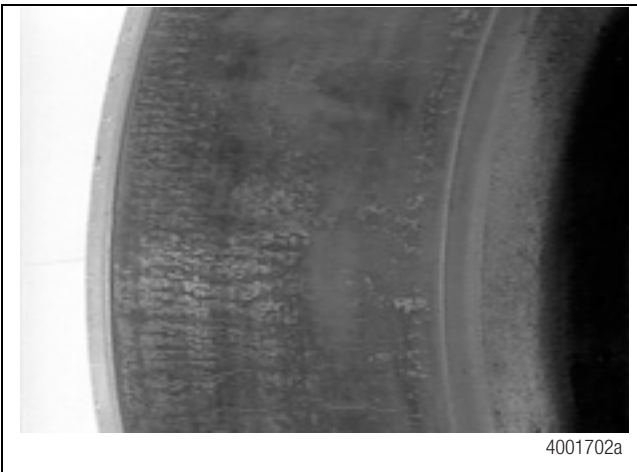

Figure 8.16

Deep Wear on Only One Side of the Drum

Deep wear on only one side of the drum indicates the drum is machined out-of-round, or the drum was dropped or bent. No evidence of hot spotting may be evident. Replace the drum. Figure 8.17.

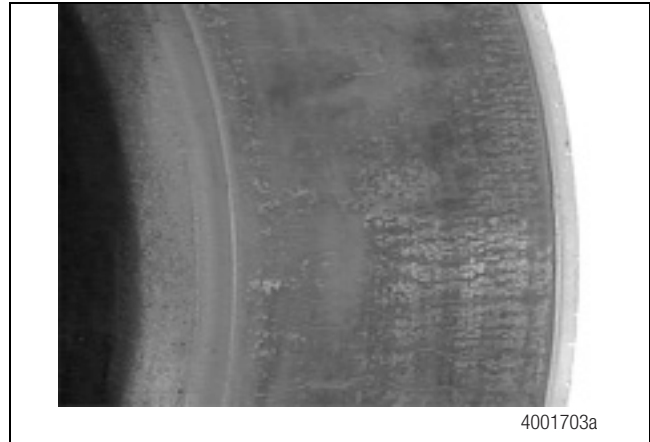

Figure 8.17

Heat Checking

Heat checking is fine lines or cracks that uniformly cover the drum's surface. Heat checking is a normal condition that results when the drum's friction surface continually heats and cools. However, if the drum operates under high temperatures or overloaded conditions or if the vehicle operates under heavy braking, larger cracks can develop and extend below the surface.

What To Look For

Fine lines and cracks over the entire drum surface that are less than one-inch (25.4 mm) in length.

What To Do

Replace the drum.

Prevention

Follow Meritor's recommended operating guidelines, maintenance practices and service procedures. Figure 8.18.



Figure 8.18

Heat Checking on Only One Side of the Drum

What To Look For

Look for fine cracks on only one side of the drum surface. However, cracks that are one-inch (25.4 mm) or more are usually deep and require drum replacement. Hot spotting may or may not be evident, and you also may find deep wear on the same side of the drum.

Heat checking on only one side of the drum can indicate that the drum is machined out-of-round, it was dropped or bent, or the drum-to-pilot fit has too much end play. Figure 8.19 and Figure 8.20.

What To Do

Replace the drum.

Prevention

Follow Meritor's recommended operating guidelines, maintenance practices and service procedures.



Figure 8.19

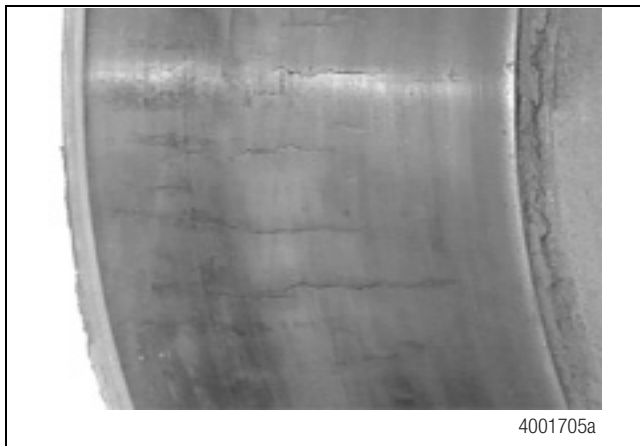

Figure 8.20

Conditions That Can Cause Failures to Occur

Black Spots (Hot Spotting) on the Drum's Surface

What To Look For

Black spots are on the entire drum surface (uniform), are on only one side of the drum surface, or are in three equidistant areas of the drum surface.

Some causes of hot spotting are water contacted the overheated drum, causing the drum to cool unevenly; the brake drum's not centered to the lining; the brake lining and drum mating surfaces burnished too slowly; brake drag occurred during operation; the linings are extremely hard; or the type of lining installed wasn't approved by the original equipment manufacturer. Figure 8.21, Figure 8.22 and Figure 8.23.

What To Do

Replace the drum.

Prevention

Follow Meritor's recommended operating guidelines, maintenance practices and service procedures. Operate the vehicle within its approved application and weight limits.

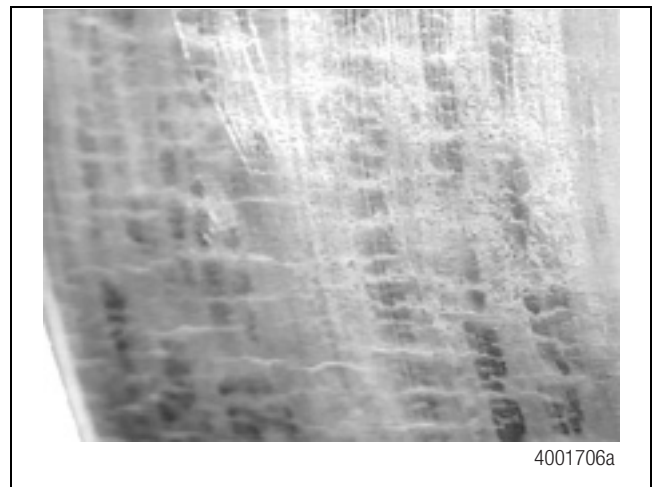

Figure 8.21

8 Cam and Air Disc Brakes

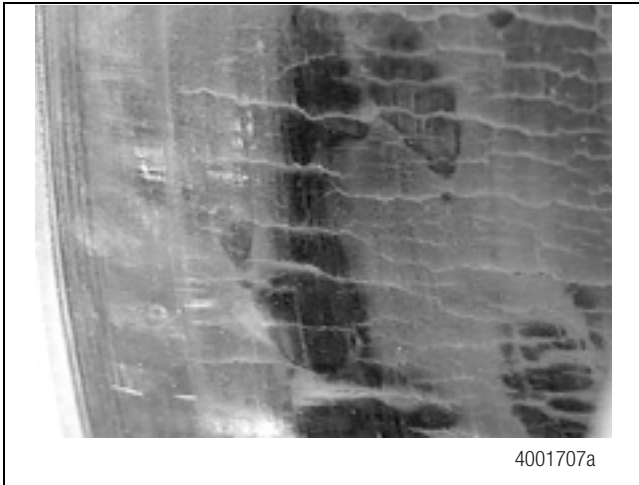

Figure 8.22

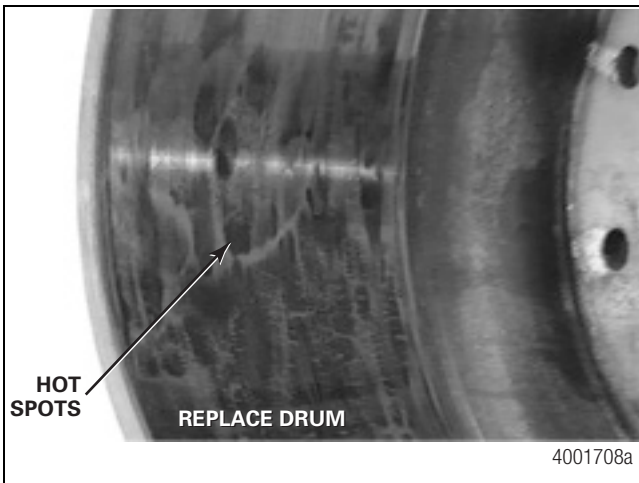

Figure 8.23

Polished (Glazed) Drum

What To Look For

A polished (glazed) drum has a mirror-like finish on the friction surface caused by an incorrect friction material, brake imbalance, low-pressure braking or the type of lining installed wasn't approved by the original equipment manufacturer. Figure 8.24.

What To Do

Replace the drum.

Prevention

Follow Meritor's recommended operating guidelines, maintenance practices and service procedures. Operate the vehicle within its approved application and weight limits.

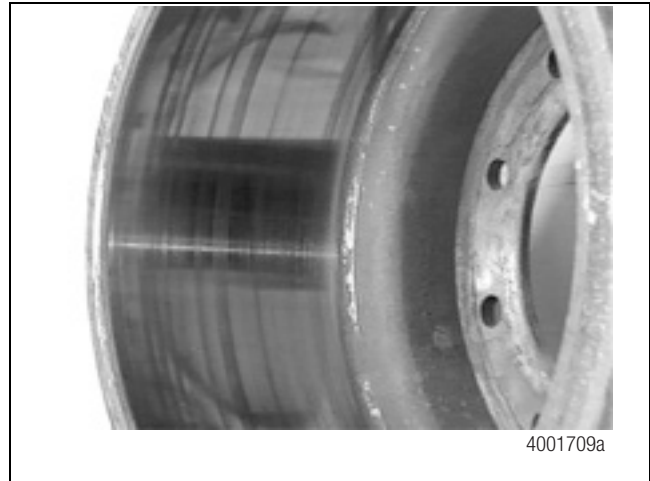

Figure 8.24

Scoring

What To Look For

Look for grooves or scratches (scoring) on the surface of a drum deeper than 0.10-inch (2.54 mm) and wider than 0.030-inch (0.076 mm), which was caused by metal-to-metal contact from worn brake pads or shoes, or debris caught between the friction material and the friction surface. Figure 8.25.

What To Do

Replace the drum.

Prevention

Follow Meritor's maintenance practices and service procedures. Operate the vehicle within its approved application and weight limits.

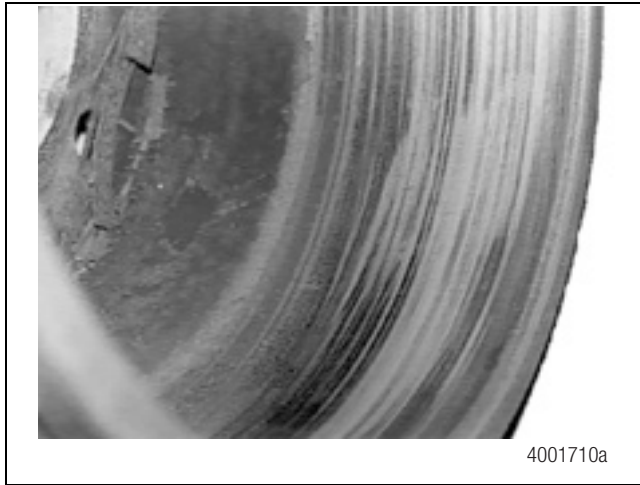

Figure 8.25

“Blue” Drum

What To Look For

Very high operating temperatures can cause the brake drum to turn a blue color, and components are damaged.

Some causes of a blue drum are the axle and wheel-end imbalance has occurred, the lining wasn't approved by the original equipment manufacturer, the braking system is incorrect for the application, or brake drag occurred during operation. Figure 8.26.

What To Do

Replace the drum or rotor.

Prevention

Follow Meritor's maintenance practices and service procedures. Operate the vehicle within its approved application and weight limits.

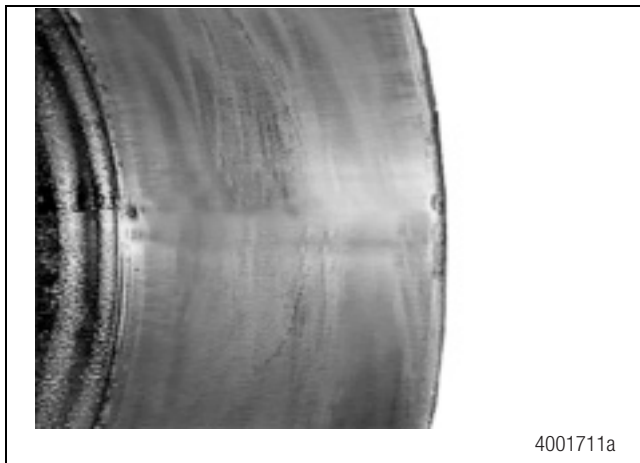

Figure 8.26

Broken Bolt Flange (Drum Surface Not Cracked)

What To Look For

The bolt flange is broken, but the drum surface isn't cracked. This situation usually results when an incorrect drum was assembled onto a hub or spoke wheel. When the fasteners were tightened, the clamping load cracked the flange. Flanges can also break if both brake shoes don't contact the drum at the same time. Figure 8.27.

What To Do

Replace the drum.

Prevention

Follow Meritor's service instructions for assembly and disassembly procedures.



Figure 8.27

Broken Bolt Flange (Cracked Drum Surface)

What To Look For

High temperatures caused the expanding brake shoes to separate the bolt flange from the drum with enough force to crack the drum, but the flange remained intact. A cracked drum surface occurs from excessive wear, heat checking or hot spotting, or a combination of these conditions. Figure 8.28.

Sometimes, however, the bolt flange breaks, but the drum doesn't crack. This condition usually occurs because the drum pilot interfered with the hub or wheel pilot, or the drum was broken before assembly.

8 Cam and Air Disc Brakes

What To Do

Replace the drum.

Prevention

Operate a vehicle within its approved application and weight limits.



Figure 8.28

Cracked Drum

What To Look For

The drum has cracked, but may not show signs of wear, heat checking or hot spotting. A drum can crack when the parking brake is set while the brakes are very hot. The cooling drum contracted on the brake shoes with enough force to crack the drum.

Brake drum pilot interference with the hub or wheel pilot also can cause the entire cross section of the drum to crack, if the drum was forced onto the pilot. Figure 8.29.

What To Do

Replace the drum.

Prevention

Operate the vehicle within its approved application and weight limits. Follow Meritor's maintenance practices and service procedures.

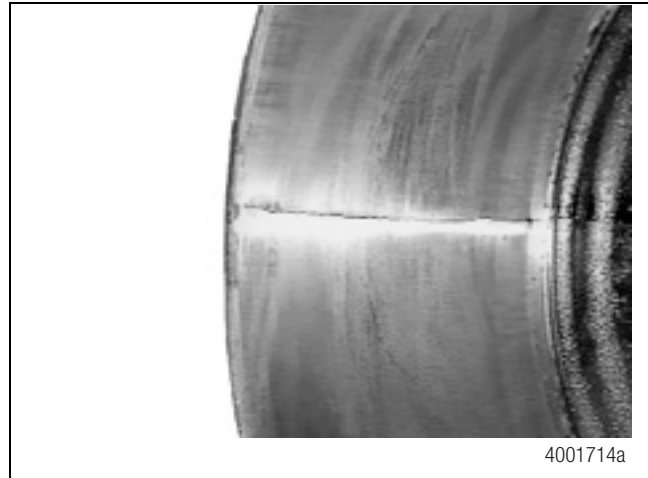

Figure 8.29

Worn Brake Drum Bolt Holes

What To Look For

Worn bolt holes result because the bolts weren't tightened to the correct torque specification. Drum pilots also can be worn and damaged, and runout in the brake drum could have occurred. Figure 8.30.

What To Do

Replace the hub and drum.

Prevention

Operate the vehicle within its approved application and weight limits. Follow Meritor's maintenance practices and service procedures.



Figure 8.30

Oil or Grease Has Penetrated and Discolored the Drum Surface

What To Look For

The brake system has been contaminated with lubricant when the following conditions are evident: oil or grease has penetrated the drum's surface; the brake drum is discolored; and lubricant is evident on the components, which resulted from wheel or hub oil seals that leaked. All of these conditions require drum replacement. Figure 8.31.

What To Do

Try to remove the oil or grease from the drum. If it can't be removed completely, replace the drum.

Prevention

Follow Meritor's maintenance practices and service procedures.

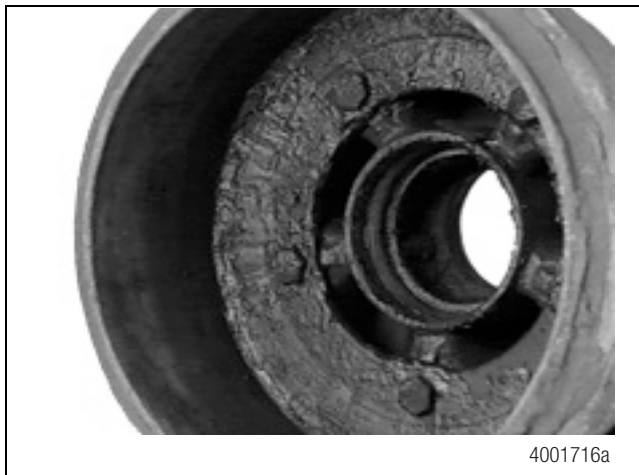

Figure 8.31

8 Cam and Air Disc Brakes

Conditions That Can Affect Brake Drum Wear

Table D: Causes of Brake Drum Wear

Condition	Possible Causes
Brake drag	Worn camshaft bushings Damaged or plugged relay valves or air exhaust ports Incorrect slack adjuster operation Bent air chamber push rods Weak or broken air chamber or shoe return springs Swelling and growth of new linings Air system imbalance Pinched air hoses or tubing
Excessive drum-to-pilot end play	Mating hub or wheel pilot machined under-size Hub or wheel pilots not centered to bearing bores Hub pilots are contaminated or corroded Drum incorrectly assembled onto pilot Drum not centered to lining
Drum is incorrectly seated on the hub or pilot wheel	Corroded mounting surface Corroded aluminum hub and drum assembly Iron or aluminum hub pilot not correctly clean prior to installation
Both brake shoes don't contact the drum at the same time	Brake drum isn't centered to the hub
Heavy braking	Braking system incorrect for the application Linings not approved by the original equipment manufacturer Operator technique High-temperature applications (city and construction) Brake imbalance Bent spiders Bent shoes don't uniformly contact the brake surface
Brake imbalance	Pneumatic imbalance between the axles Plugged or corroded relay valves Linings not approved by the original equipment manufacturer Incorrect brake power (AL Factor) Imbalance between the apply and release threshold pressures

Parts Analysis Overview

Evaluate Damaged Transmission Components

⚠ WARNING

To prevent serious eye injury, always wear safe eye protection when you perform vehicle maintenance or service.

This section provides a parts analysis investigative process to help you determine why transmission components fail during operation, what to look for when you inspect the parts, and how to help prevent failures from occurring again.

Most of the time, you can find the answers you need by visually inspecting a failed component. Sometimes, however, this process may require specialized knowledge or equipment.

Why a product fails can be difficult to determine, and a failure can vary in appearance from vehicle to vehicle. Failures in models from the same manufacturer can also vary, so it is important to use the information presented here as a guide, not a rule, when you perform parts analysis inspections.

Causes of Transmission Failures

Metal mating surfaces wear as a transmission operates. Transmission oil helps to minimize spur gear wear, because oil protects components from metal-to-metal contact. The most common types of wear conditions on spur gears are frosting, offset frosting, pitting, spalling, scoring, shock load and fatigue fractures.

Parts Analysis Process

Spur Gears

Cause of Failure

Heavy or deep pitting damaged the spur gear.

Pitting is a type of surface fatigue that forms pits, or cavities, on metal surfaces. If pitting is heavy, it can progress until pieces of surface metal break, or spall, from a component. This is called “spalling.”

What To Look For

Look for heavy or deep pitting on the entire spur gear tooth contact surface. Spur gears damaged by heavy pitting require replacement.

Verify that the lubricant installed was the correct specification and viscosity. Were different types of oil mixed together and installed in the vehicle? Was the vehicle operated with sufficient lubricant? Was the vehicle maintained according to Meritor’s recommended maintenance practices?

Prevention

Operate the vehicle within its approved application and weight limits. Follow Meritor’s recommended maintenance practices and service procedures.

Spur Gears

Cause of Failure

Spalling damaged the spur gear.

When the metal surface of a component breaks into chips or fragments as a result of wear fatigue, the condition is called “spalling.” Spalling is a type of surface fatigue and is evident in the advanced stages of heavy pitting. Spur gears damaged by spalling require replacement.

What To Look For

Spalling on spur gear teeth looks similar to heavy pitting, but the cavities are usually larger in diameter and shallower in depth. Figure 9.1. Was the gear overloaded?

Prevention

Operate the vehicle within its approved application and weight limits. Teach drivers how to correctly operate a vehicle.

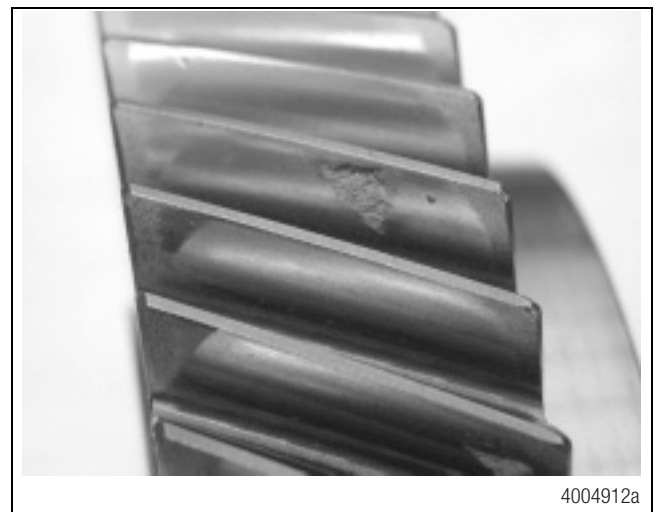

4004912a

Figure 9.1

9 Transmissions

Spur Gears

Cause of Failure

Galling or “metal transfer” damaged the spur gear.

Galling, also called “metal transfer,” occurs when two unlubricated metal surfaces rub against each other, usually as a result of high operating temperatures caused by insufficient lubrication.

Figure 9.2 and Figure 9.3 show how metal separated from the gear teeth and welded to the mating gear teeth. Spur gears damaged by galling require replacement.

What To Look For

Verify that the correct lubricant was installed, not multi-viscosity engine oil or extreme pressure (EP) GL-5 oil. Also, were different types of oil mixed together and installed into the vehicle? Was the vehicle operated with insufficient lubricant and under high operating temperatures?

Were any seals leaking? Was the vehicle maintained according to Meritor’s recommended maintenance practices?

Prevention

Follow Meritor’s recommended maintenance practices and service procedures.



4004913a

Figure 9.2

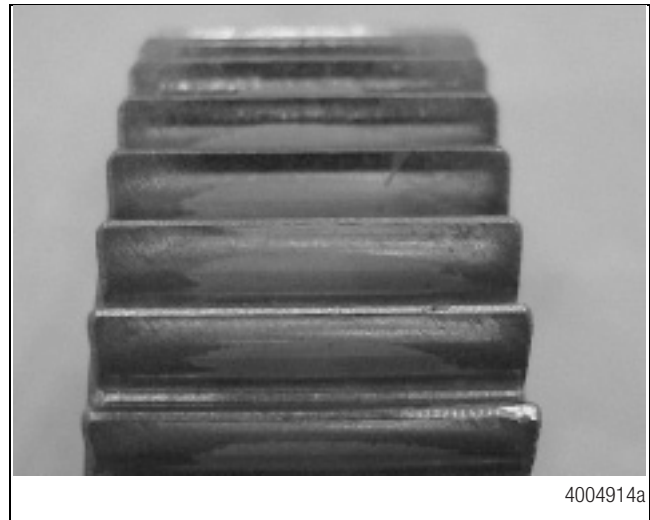

4004914a

Figure 9.3

Spur Gears

Cause of Failure

Shock load damaged the spur gear.

Shock load occurs when a sudden and powerful force is applied against a component. Shock load can destroy or damage a component immediately. Often, however, a component damaged by shock load will continue to operate, but it will wear prematurely or fail soon after the initial shock load has occurred.

Shock load causes components to crack and separate from each other. Spur gears damaged by shock load require replacement.

What To Look For

Examine the entire transmission. If teeth have broken from the gear, check for subsequent damage that may have occurred as a result. Look for a rough, crystalline finish on the surface of the spur gear. Figure 9.4, Figure 9.5 and Figure 9.6.

Also try to determine if the operator backed into a loading dock with excessive force, or if the vehicle’s spinning wheel hit dry pavement. Did the operator miss a shift? Did the operator speed up the engine and rapidly release the clutch (“popping the clutch”)?

Prevention

Teach drivers how to correctly operate a vehicle.

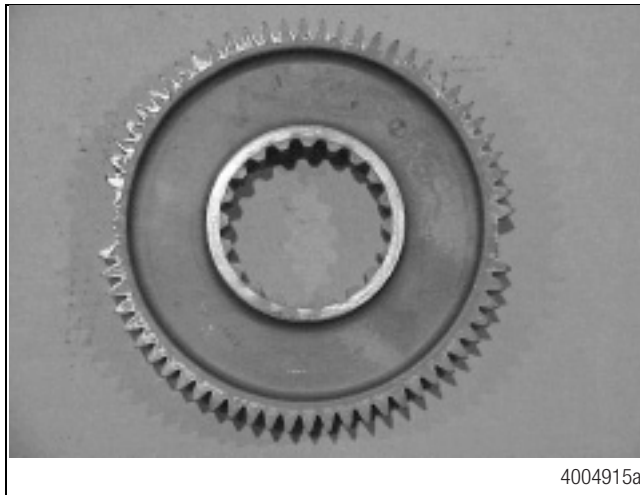

Figure 9.4

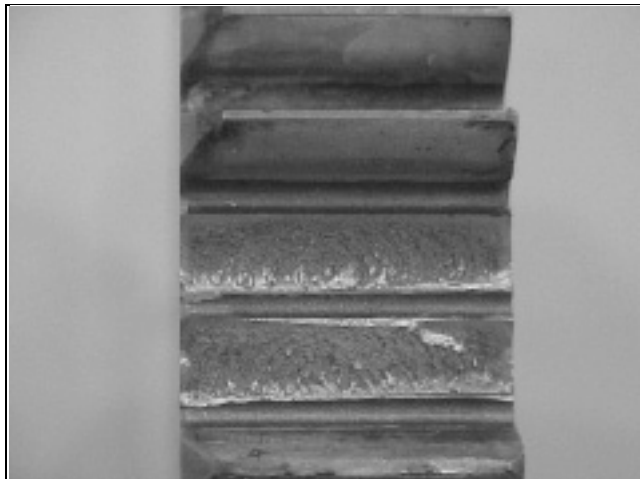

Figure 9.5

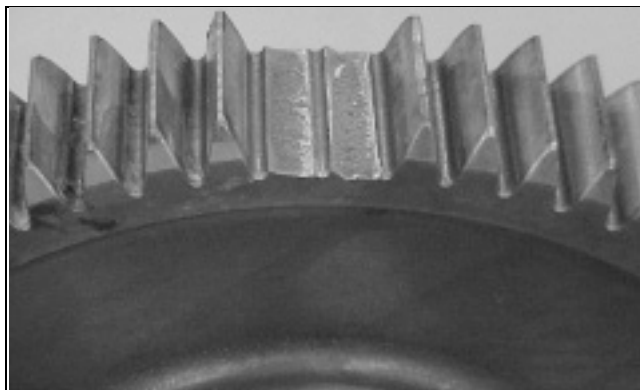

Figure 9.6

Spur Gears

Cause of Failure

Fatigue fracture damaged the spur gear.

Fatigue fracture is caused by cyclic torque overloads on a component, torsional vibration, and twisting and bending. A fatigue fracture quickly reduces the overall strength of a gear, reducing its ability to withstand operating load. Figure 9.7.

What To Look For

A fatigue fracture begins at one or more points. Look for ratchet marks and subsequent beach marks on the part. Beach marks represent fatigue cycles that occurred before the component failed completely. Visually, beach marks are smooth, curved radial lines that originate from the fracture site. At the failure site, however, beach marks are rough and brittle. Spur gears damaged by fatigue fracture require replacement.

Prevention

Operate the vehicle within its approved application and weight limits.

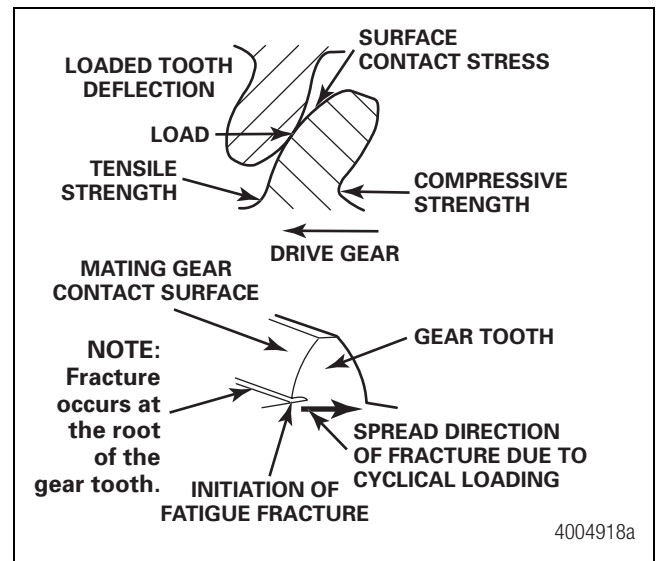

Figure 9.7

9 Transmissions

Spur Gears

Type of Wear

Frosting damaged the spur gear.

What To Look For

Frosting is a grayish or yellowish white color usually found at the center of the teeth at the mating gear contact position. Light pitting on the gear teeth also may accompany frosting. Figure 9.8, Figure 9.9 and Figure 9.10.

Offset frosting has the same characteristics as frosting, but appears at one side of the spur gear face. Offset frosting is caused by a difference in the gear tooth contact face from one side to the other, or from a slight shift in gear set loading.

Prevention

No action is required. Frosting is a normal wear condition on spur gear teeth that does not affect performance or gear life. As the gear continues to operate, sliding friction eventually removes frosting. If frosting is the only wear you see on spur gears, do not replace the gears.

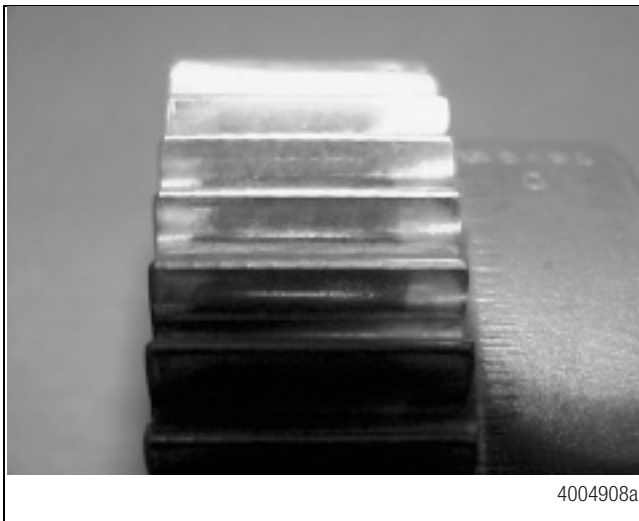

Figure 9.8

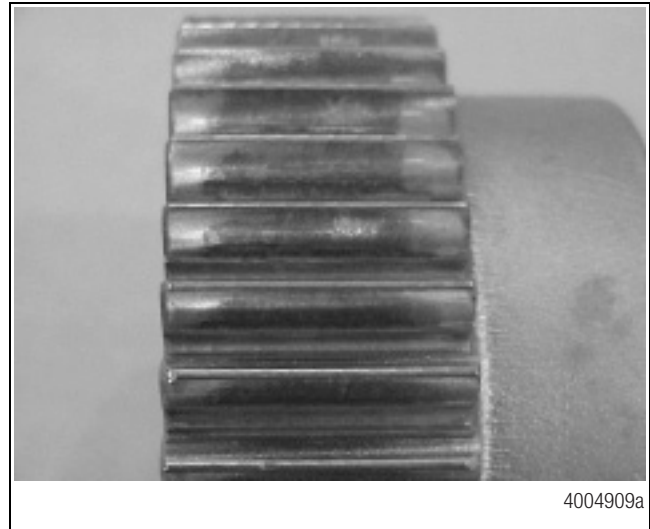

Figure 9.9



Figure 9.10

Roller Bearings

Cause of Failure

Heavy pitting damaged the roller bearings and most likely changed bearing adjustment and bearing alignment.

Pitting is a type of surface fatigue that forms pits, or cavities, on metal surfaces. Figure 9.11. If pitting is heavy, it can progress until pieces of surface metal break, or spall, from a component.

What To Look For

Inspect the cup and cone contact areas, cage inner and outer surfaces, cage roller pockets, roller body, and roller end for wear. Verify that the lubricant installed was the correct specification and viscosity. Were different types of oil mixed together and installed in the vehicle? Was the vehicle operated with sufficient lubricant?

If you find pitting on the roller bearing, it indicates that fatigue damage had begun, and roller bearing replacement is required.

Prevention

Operate the vehicle within its approved application and weight limits. Follow Meritor's recommended maintenance practices and service procedures.



Figure 9.11

Roller Bearings

Cause of Failure

Excessive end play loosened the rollers in the bearing cage, which caused the bearing rollers to damage the cage.

What To Look For

Look for wider bearing pockets and "skidding" wear on the cup and cone surface. Figure 9.12 and Figure 9.13. "Skidding" wear occurs when the wider bearing pockets enable the rollers to turn at an angle in the pocket, and then snap back into place. A bearing damaged by excessive end play requires replacement.

Prevention

Follow Meritor's recommended service procedures to adjust end play.

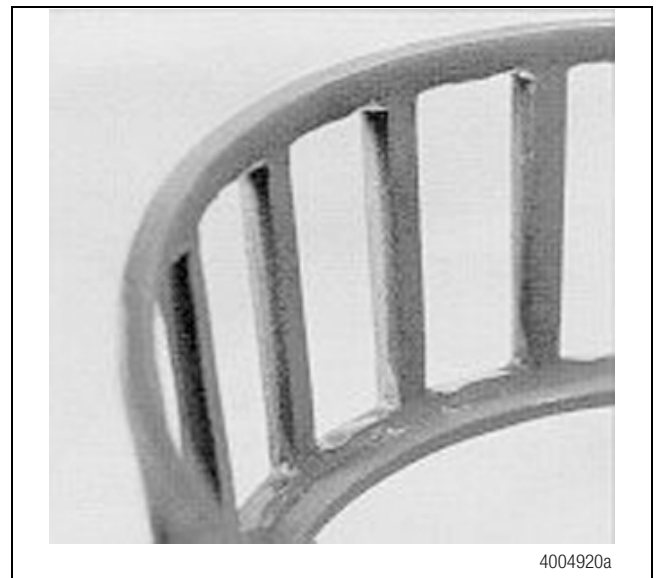

Figure 9.12

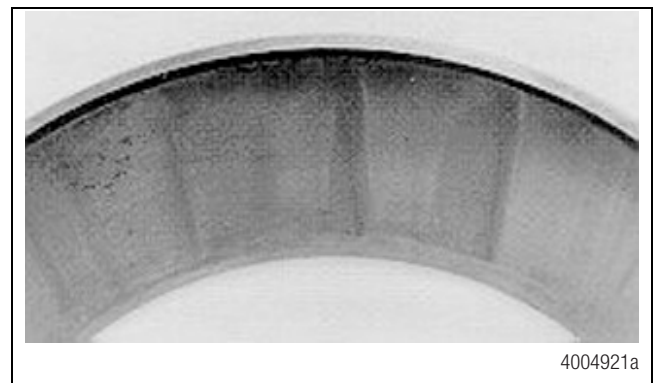

Figure 9.13

9 Transmissions

Roller Bearings

Cause of Failure

Brinelling displaced the metal on the bearing surface of the cup and cone.

What To Look For

Look for machined marks and displaced metal on the bearing cup and cone. Figure 9.14. A bearing damaged by brinelling requires replacement.

Prevention

Operate the vehicle within its approved application and weight limits. Teach drivers how to correctly operate a vehicle.

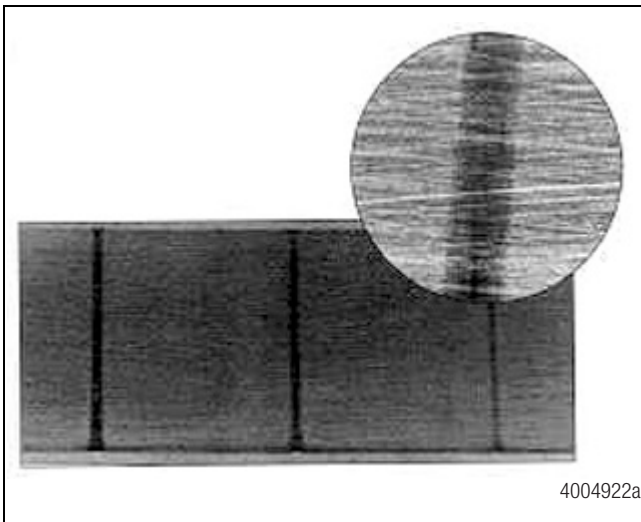

Figure 9.14

Roller Bearings

Cause of Failure

Etching, also called “corrosion”, damaged the roller bearings because moisture entered the transmission through a worn seal or by condensation. Etching usually develops before pitting occurs.

What To Look For

Etching is a dark surface stain on the roller bearing. Figure 9.15. A bearing damaged by etching requires replacement.

Prevention

Follow Meritor’s recommended maintenance practices and service procedures.



Figure 9.15

Roller Bearings

Cause of Failure

The transmission was insufficiently lubricated, which caused the bearing to overheat and seize.

What To Look For

A bearing damaged by insufficient lubricant will overheat, and you’ll see that its color has changed from silver to deep blue. If the bearing is black, it is an indication that it seized and caused metal to separate from the bearing and weld to other mating components. Figure 9.16 and Figure 9.17. Bearings damaged by insufficient lubricant require replacement.

Look for leaking transmission seals and other damaged transmission components.

Prevention

Follow Meritor’s recommended maintenance practices and service procedures.



Figure 9.16



Figure 9.17

Roller Bearings

Cause of Failure

The bearings weren't correctly aligned, which concentrated the load onto one side of the bearing, instead of distributing it evenly across the entire bearing surface.

What To Look For

Look for uneven wear damage on the bearing, as well as spalling on the cup and cone. Both conditions require bearing replacement. Figure 9.18 and Figure 9.19.

Prevention

Follow Meritor's recommended service procedures to correctly align bearings.

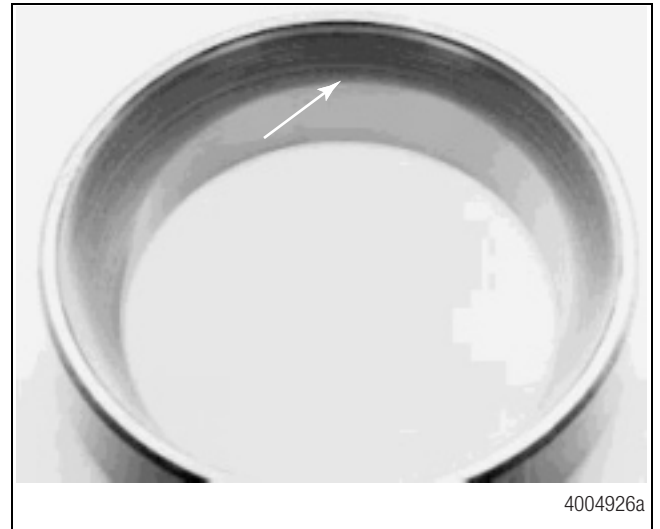

Figure 9.18

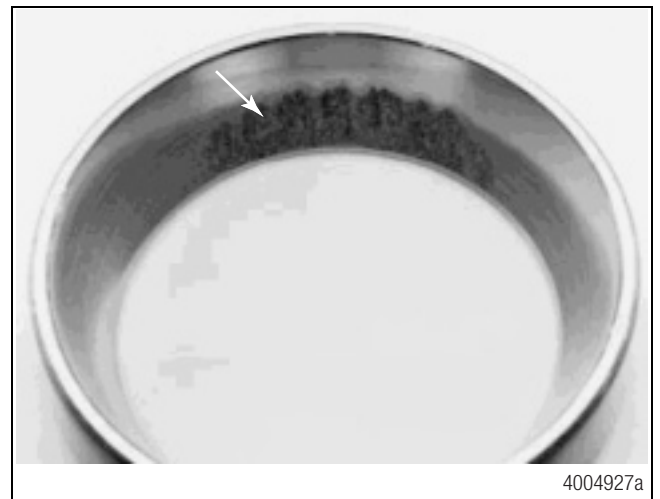

Figure 9.19

9 Transmissions

Main Shaft Washer

Cause of Failure

Insufficient lubricant caused high operating temperatures that damaged the washer. The driver operated the vehicle incorrectly. Figure 9.20. Shock load occurred, which damaged the transmission. Figure 9.21.

Shock load occurs when a sudden and powerful force is applied against a component. Shock load can destroy or damage a component immediately. Often, however, a component damaged by shock load will continue to operate, but it will wear prematurely or fail soon after the initial shock load has occurred.

Shock load causes components to crack and separate from each other. Main shaft washers damaged by shock load require replacement.

What To Look For

Check the main shaft spacing. If it is too tight, metal-to-metal contact occurs, which results in high operating temperatures that damaged the main shaft. Figure 9.22.

Figure 9.20 shows a shift collar that is forced into gear, because the driver didn't use the clutch or synchronize the gear shift. The mating gear snap ring, washer and spacer absorbed the force and caused lubricant between the washer to displace. High operating temperatures occurred that damaged the main shaft washer; and if enough force is applied, the spacer and snap ring could break. Shock load also causes components to crack and separate from each other. Look for a rough, crystalline finish on the separated parts.

Look for fractured teeth on the main shaft gear, which occurs when the gear doesn't contact the mating countershaft gears.

Figure 9.21. The fracture didn't occur on the entire surface of the teeth, and the gear will be out-of-position. Check the sliding shift collars and the teeth on the clutch collar for fractures and excessive wear, which are signs of grinding gears. Figure 9.23.

Try to determine if the driver either coasted with the transmission in gear and the clutch disengaged, or with the transmission in neutral and the auxiliary case in low range. Was the vehicle towed; and if so, was it towed correctly?

If the main shaft washer is fractured, was it dropped during assembly? Figure 9.24. Is there evidence of heat checking? Did shift lever slip out (not jump out) occur? Is the snap ring damaged?

Prevention

Teach drivers to correctly operate a vehicle. Follow Meritor's recommended maintenance practices and service procedures.

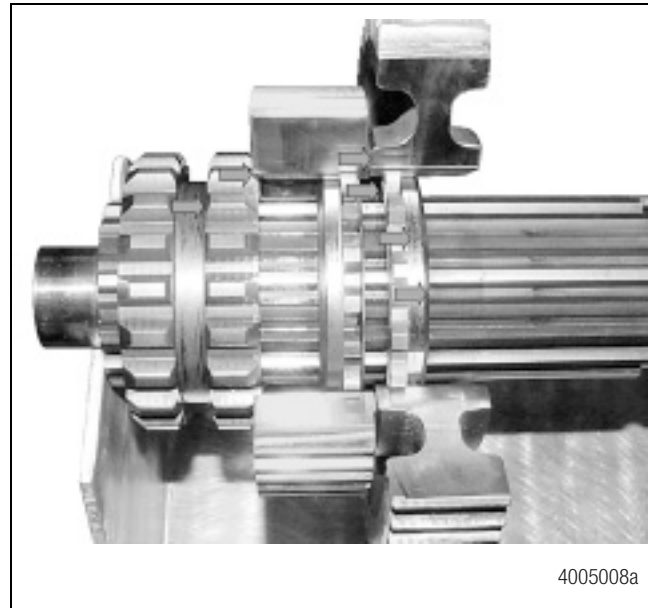

Figure 9.20

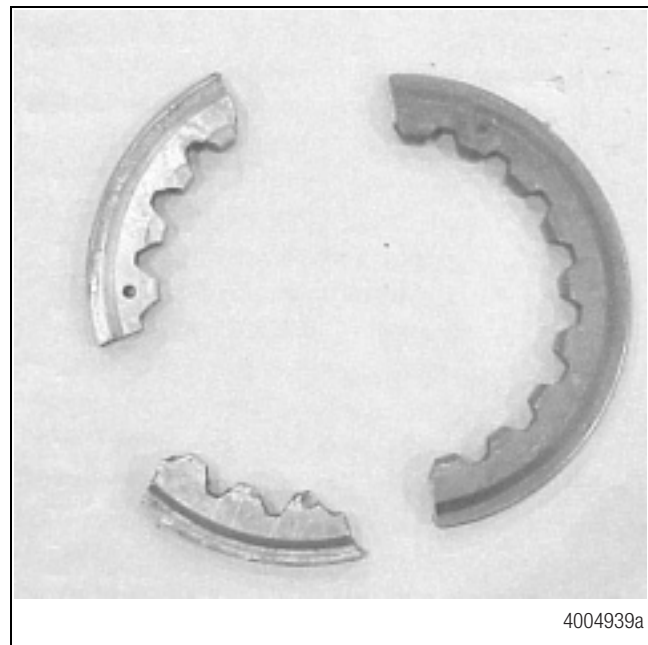

Figure 9.21

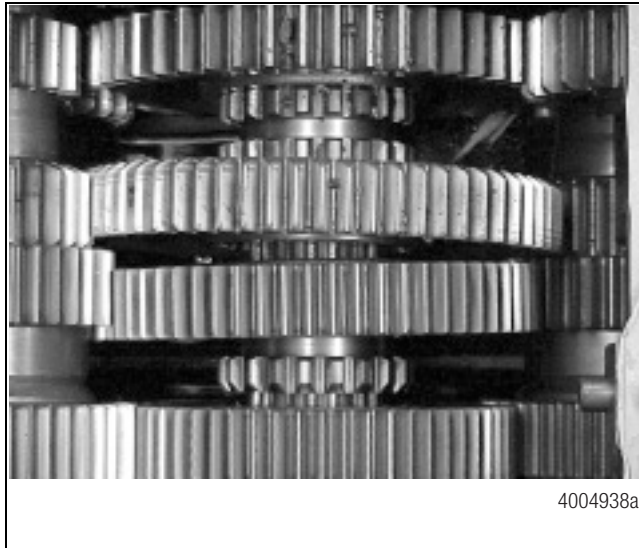

Figure 9.22

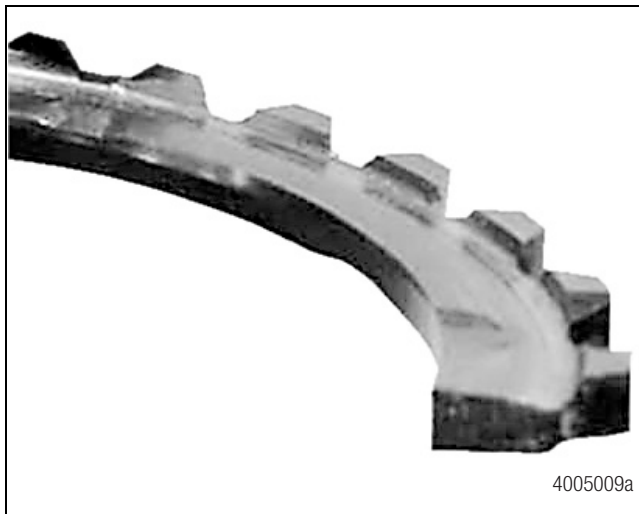

Figure 9.23

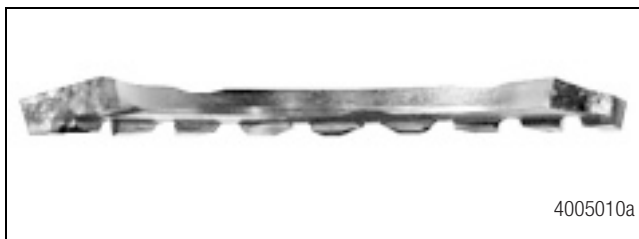

Figure 9.24

Main Shaft Gear Float Clearance

Cause of Failure

The main shaft gear float clearance is not within the correct specification. The washers and spacers were damaged by insufficient lubricant; or the operator used “float shifting,” which loaded the washers and spacers. Float shifting forces lubricant from between the washer and spacer, which damages these parts.

What To Look For

Gear Float Clearance

Gear float is the clearance between the main shaft gear mating hubs. New transmissions are factory-set with a gear float clearance of 0.006-0.012-inch (0.152-0.304 mm).

Gear float is important, because when it's correctly set, it enables lubricant to pass between the mating gears to lubricate the gear hubs, washers and spacers. If clearance is too tight, the gear hubs, washers and spacers will score, gall and burn.

Excessive clearance causes the transmission gears to rattle from torsional vibration and requires the main shaft to be rebuilt to the original factory-set clearance.

Washers and Spacers

It's normal to find wear on washers and spacers in high-mileage units. Figure 9.25. However, inspect parts for excessive wear or a “burned” look that occurs from insufficient lubricant and high operating temperatures. Figure 9.26.

The Transmission Wasn't Shifted Correctly

Try to determine if the driver shifted the transmission correctly and didn't use “float shifting.” During float shifting, the driver doesn't use the clutch, but “floats” the shift collar into gear. Look for scoring, galling, burning and fractures on the washers and spacers. Figure 9.27.

If a driver is having difficulty shifting the transmission, check for correct clutch adjustment and wear in the clutch linkage, shift linkage, shift tower and top cover. All of these conditions can damage the shift collars, washers and spacers.

9 Transmissions

Prevention

Check that gear float clearance is correct. In-service float clearance must not exceed 0.024-inch (0.068 mm), or two times the maximum factory-set clearance of 0.006-0.012-inch (0.152-0.304 mm). Figure 9.28 and Figure 9.29.

Gear float that's not within specification is beyond the service limits. Use new selective washers, snap rings and spacers to adjust the float. Optimal clearance on a rebuild is 0.012-inch (0.304 mm).

Follow Meritor's recommended maintenance practices and service procedures.

Teach drivers to shift a transmission correctly.

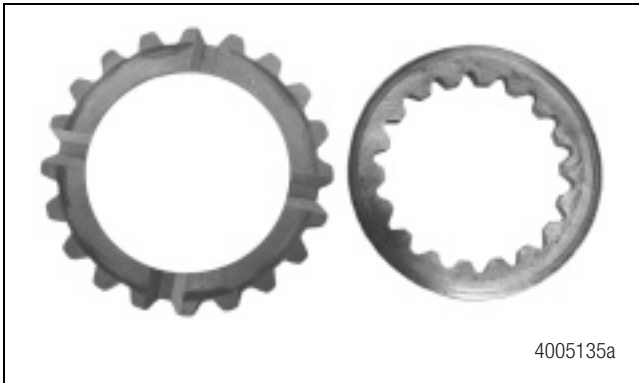

Figure 9.25



Figure 9.26

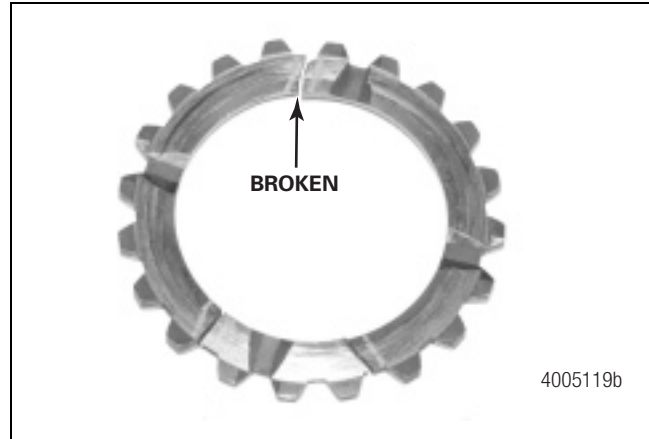

Figure 9.27

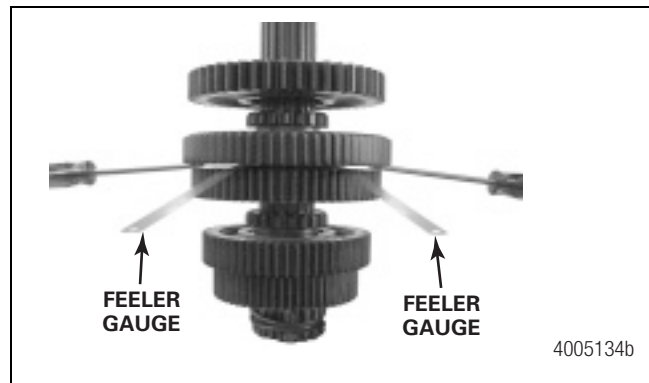

Figure 9.28

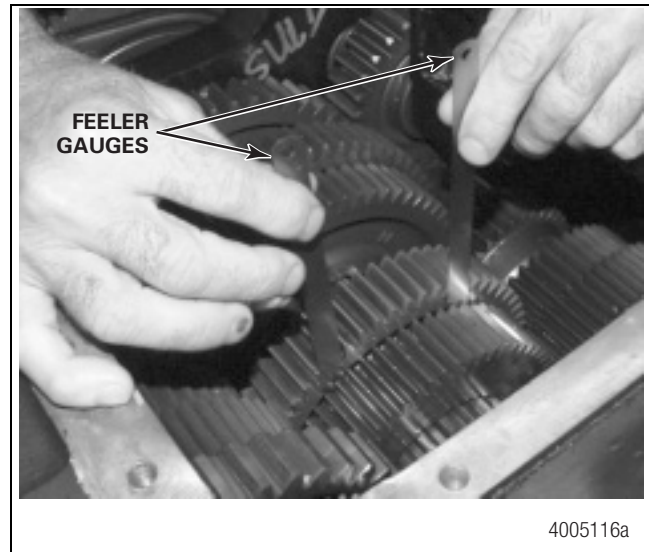

Figure 9.29

Gear Teeth

Cause of Failure

Shock load occurred that damaged the gear teeth.

Shock load occurs when a sudden and powerful force is applied against a component. Shock load can destroy or damage a component immediately. Often, however, a component damaged by shock load will continue to operate, but it will wear prematurely or fail soon after the initial shock load has occurred.

Shock load causes components to crack and separate from each other. Gears damaged by shock load require replacement.

What To Look For

Look for fractures on gear teeth at 180-degree intervals. Figure 9.30. If the shock load is severe, damage can extend to the main shaft and bearing, as well as other transmission components. Try to determine if the driver shifted the transmission incorrectly. Figure 9.31, Figure 9.32, Figure 9.33, Figure 9.34 and Figure 9.35.

Prevention

Teach drivers to correctly operate a vehicle.

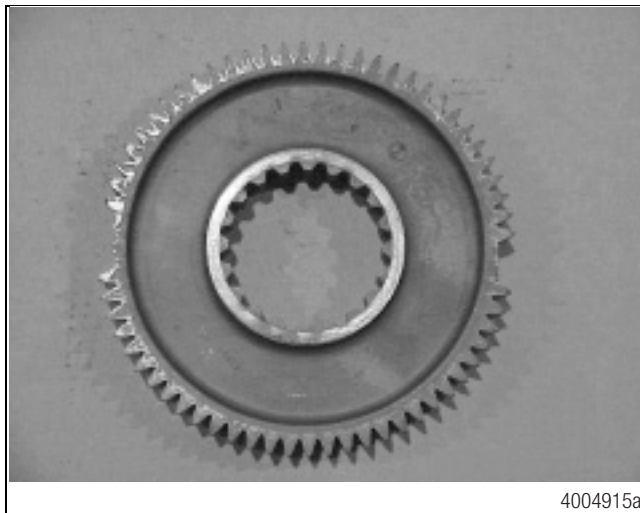

4004915a

Figure 9.30

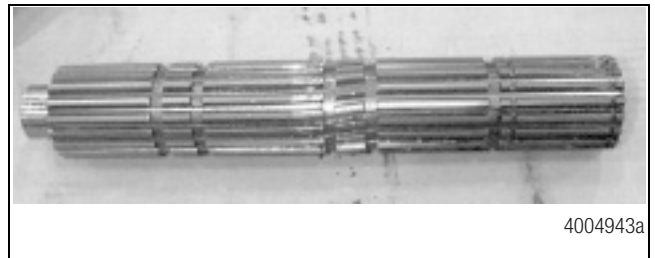

4004943a

Figure 9.31

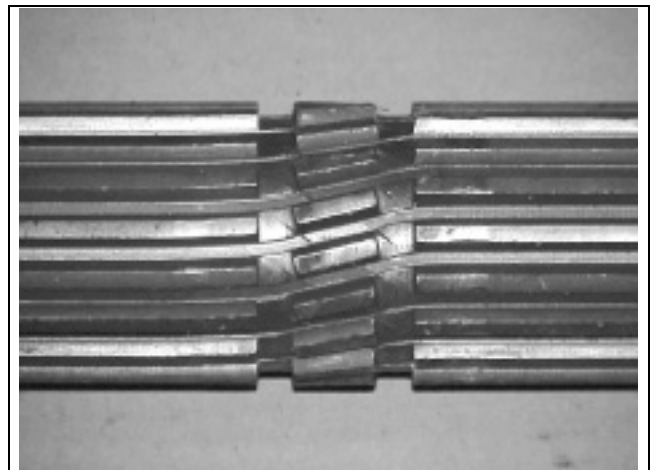

4004944a

Figure 9.32

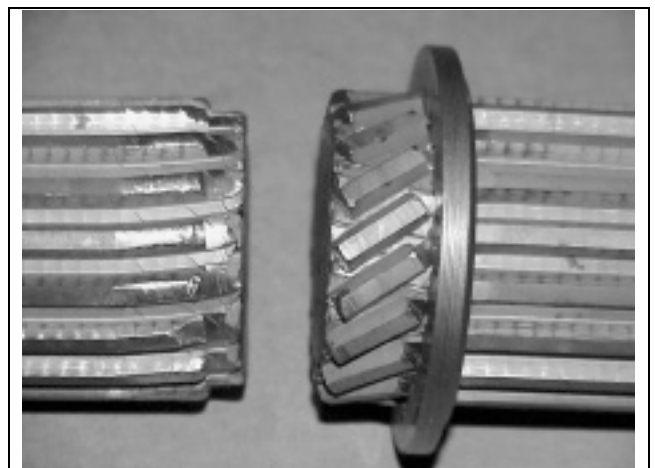

4004945a

Figure 9.33

9 Transmissions

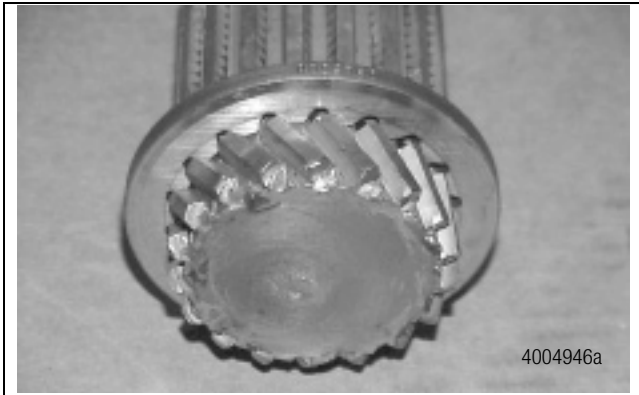

Figure 9.34

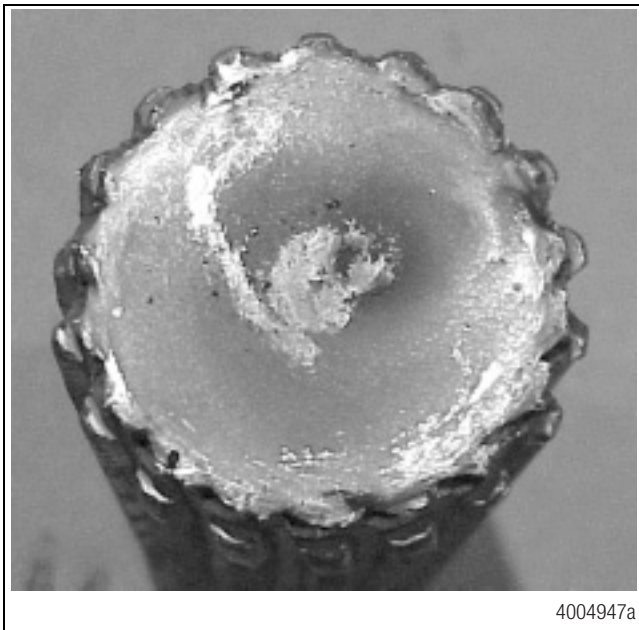

Figure 9.35

Gear Teeth

Cause of Failure

The lubricant was contaminated or the transmission was operated with insufficient lubricant.

What To Look For

Is the lubricant blackened, or has it started to solidify? If the lubricant looks blackened, does it have a burned smell? If so, it's an indication that the transmission was operated with insufficient lubricant and under high temperatures. Under these conditions, lubricant breaks down and becomes blackened and sludge-like.

Remove the top cover. Check the internal walls of the transmission case for burned lubricant residue, which bakes into the case when the transmission is operated with insufficient lubricant. If you find residue, is it contaminated with metal particles or debris?

Look for leaking transmission seals. Look for a common wear pattern on the gear teeth called "apple coring," which occurs when metal melts at high temperatures and leaves a central, concave depression in the gear teeth. Figure 9.36, Figure 9.37, Figure 9.38, Figure 9.39, Figure 9.40 and Figure 9.41.

If possible, determine if the transmission became difficult to shift, or if it was grinding or "growling" when in gear. Gears damaged by insufficient lubricant require replacement.

Prevention

Follow Meritor's recommended maintenance practices and service procedures. Operate the vehicle within its approved application and weight limits. Teach drivers how to correctly operate a vehicle.

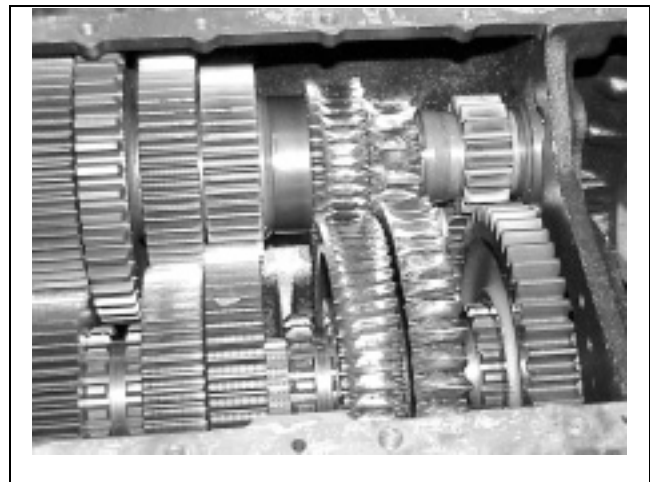

Figure 9.36

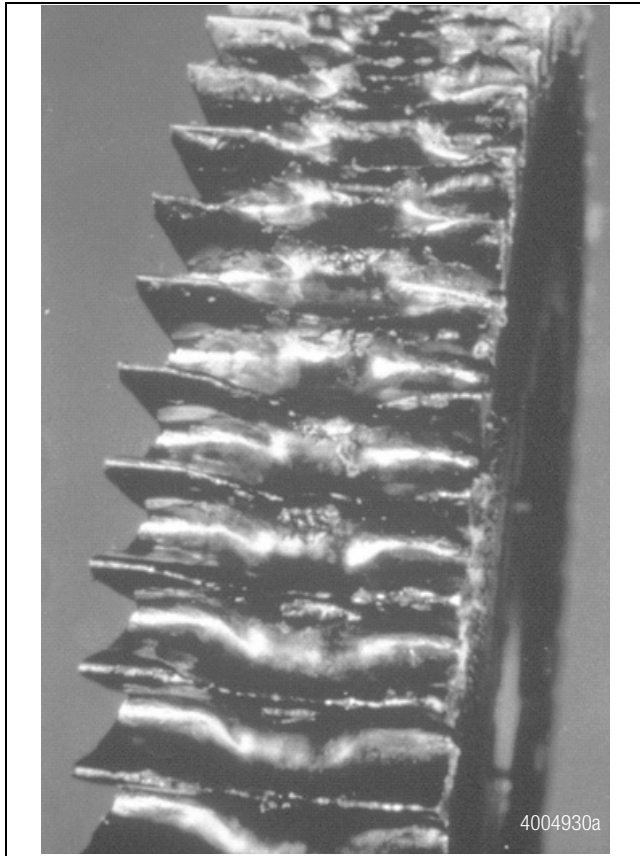
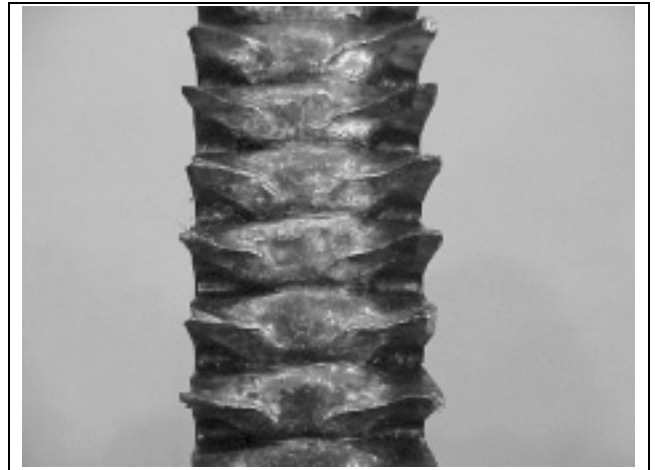

Figure 9.37

4004930a



4004932a

Figure 9.39

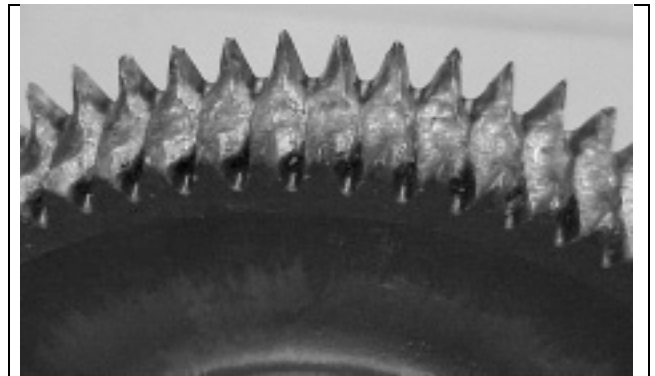

4004933a

Figure 9.40

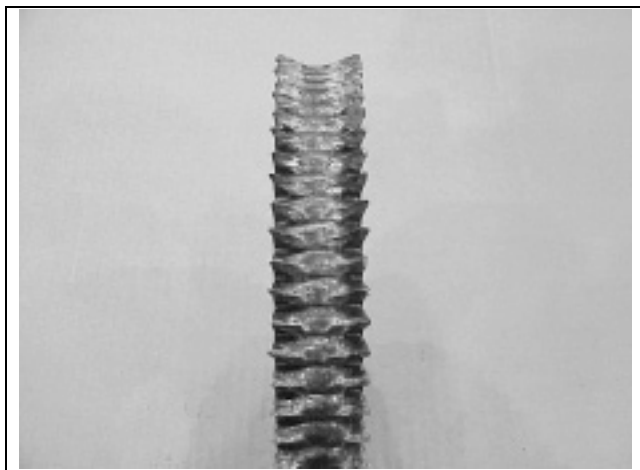

4004931a

Figure 9.38

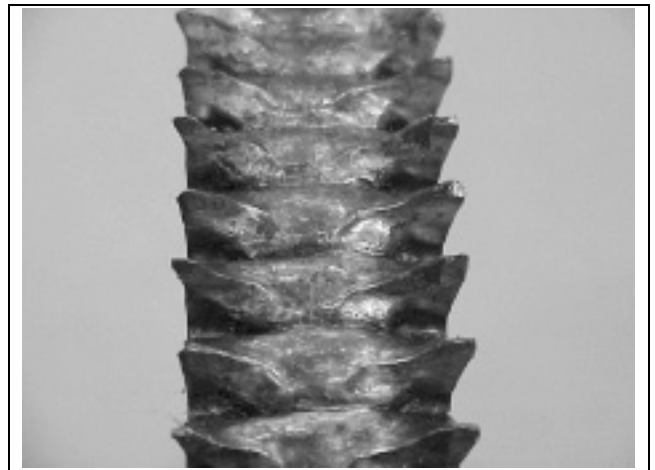

4004934a

Figure 9.41

9 Transmissions

Synchronizer Pin

Cause of Failure

Torsional vibration in the drivetrain damaged the synchronizer assembly.

Torsional vibration is a twisting and untwisting action in a shaft that's caused by the application of engine power (torque) or incorrect driveline phasing or angles. Torsional vibration is most likely absorbed at the transmission synchronizer and causes premature wear damage to all drivetrain components.

What To Look For

Check the synchronizer assembly and pins. When torsional vibration occurs, pins can be fractured. Figure 9.42, Figure 9.43 and Figure 9.44. A synchronizer damaged by torsional vibration require replacement.

Prevention

Follow Meritor recommended service procedures to verify that driveline angles and phasing are correct.

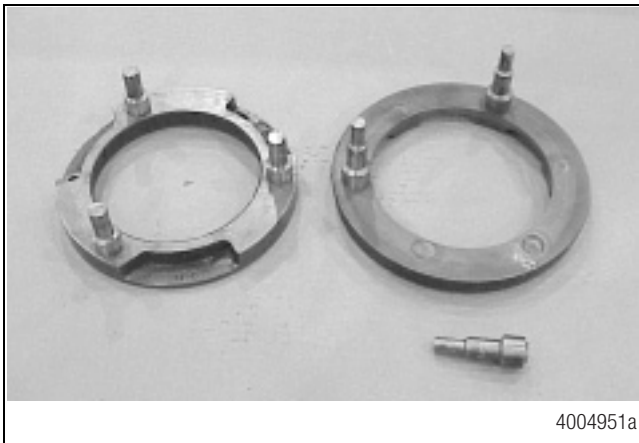

Figure 9.42

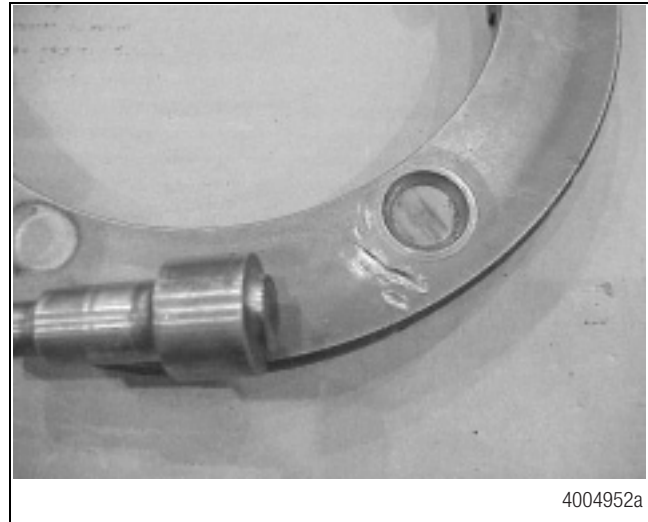

Figure 9.43

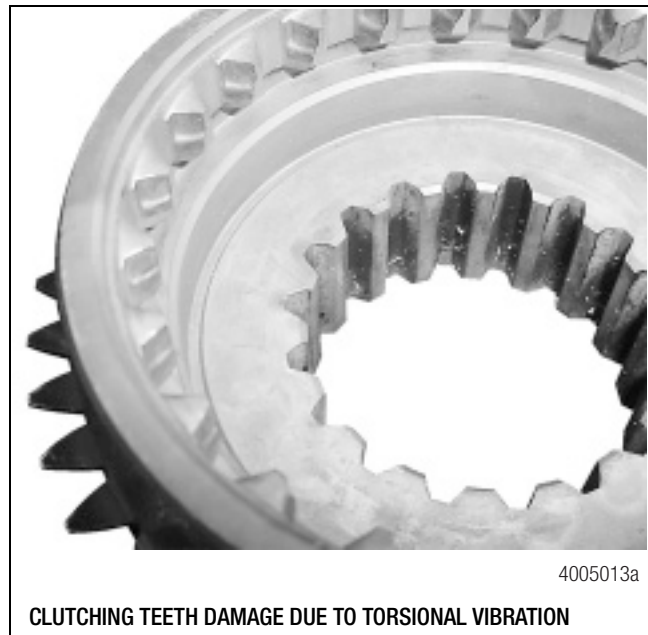

Figure 9.44

Shift Collar Wear

Cause of Failure

Shift collar teeth are worn and damaged, and full engagement doesn't occur. Replace the shift collar.

What To Look For

Shift collar teeth surfaces are worn and rounded instead of flat and trapezoid shape. Figure 9.45. Are the sides of the teeth surfaces polished? This indicates that the collar is fully engaged into the mating gear. If wear doesn't extend to the end of the tooth, the collar isn't engaging fully into the gear.

Can you still see a trapezoid shape on the ends of the teeth? Are teeth surfaces polished? If so, the shift collar is fully engaging and doesn't require replacement. Figure 9.46 and Figure 9.47.

It's normal to find shift collar damage in high-mileage transmissions. However, in lower-mileage transmissions, damage can occur if the manual shift mechanism malfunctions, the clutch is out-of-adjustment, or a driver didn't shift the transmission correctly.

Check for a bent or twisted shift fork, worn or broken top cover, worn shift tower or twisted main shaft. Verify that the shift lever motion isn't restricted.

Try to determine if the driver had difficulty shifting the transmission. Worn collars cause raking and grinding during shifting.

Prevention

Follow Meritor's recommended maintenance practices and service procedures. Operate the vehicle within its approved application and weight limits. Teach drivers to correctly shift a transmission.

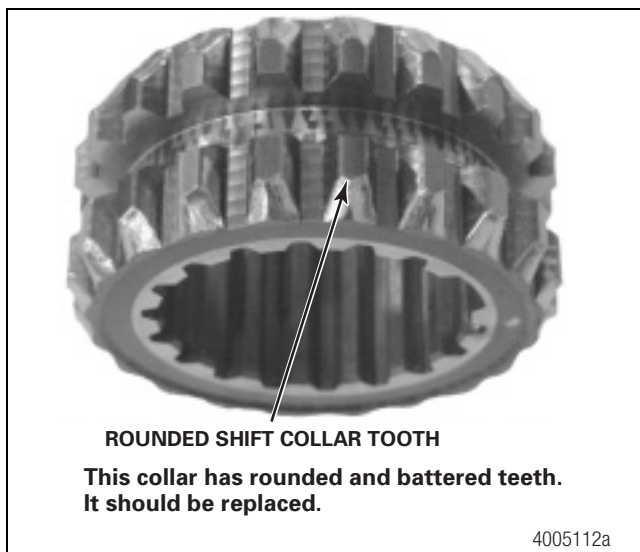

Figure 9.45

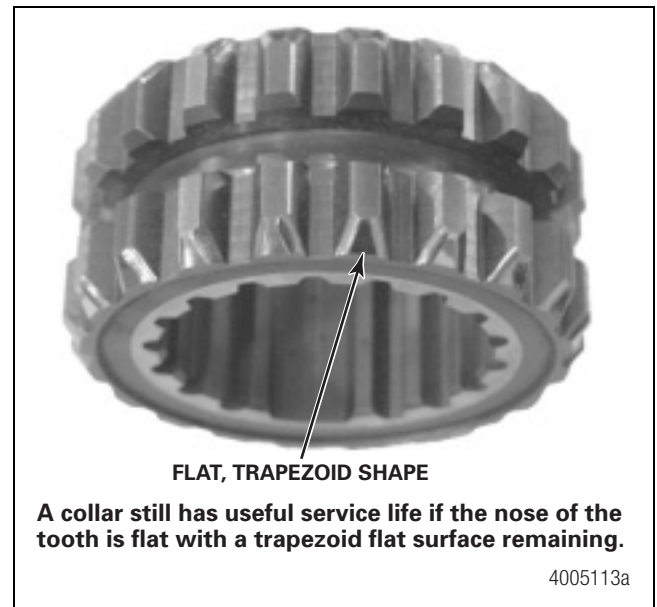

Figure 9.46



Figure 9.47

9 Transmissions

Oil Seals

If you notice moisture, wetness or oil drips on or around an axle oil seal, it's important to recognize if the seal is leaking, or if it only appears to be leaking.

How to Recognize a Leaking Seal

Inspect the oil seal and surrounding area for wetness. If the seal and area appear very wet or visibly drip oil, or if you notice oil dripping from the bottom of the output seal retainer, replace the seal.

Inspect the yoke for wetness. Check for a leak path leading to the rear lip of the seal. If you notice wetness around the yoke hub or a leak path leading to the rear lip of the seal, replace the seal.

How to Recognize a Seal That Appears to be Leaking

Seals come prelubricated with grease that melts at low temperatures under normal operating conditions. Melted grease can moisten or wet the area between the yoke and the oil seal lip. When this happens, you won't find a leak path leading to the seal. If you notice a moist seal and don't find a leak path, do not replace the seal.

A seal can also become moist from lubricants applied to the yoke or retainer bolts during assembly. When this happens, you won't find a leak path leading to the seal. If you notice a moist seal and don't find a leak path, do not replace the seal.

Seal Test Procedure

1. Thoroughly clean and dry the area around the entire seal retainer casting, especially at the top.
2. Drive the vehicle for 15-20 minutes at highway speeds.
3. Check for wetness or moisture on or around the seal. Also check for oil dripping from the seal. If you notice either of these conditions, replace the seal.

Example 1: The Seal is Not Leaking

Cause of Failure

None

What To Look For

There's slight moisture from packing grease at assembly, but the area around the seal is dry. Figure 9.48.

Prevention

Follow Meritor's recommended maintenance practices and service procedures.

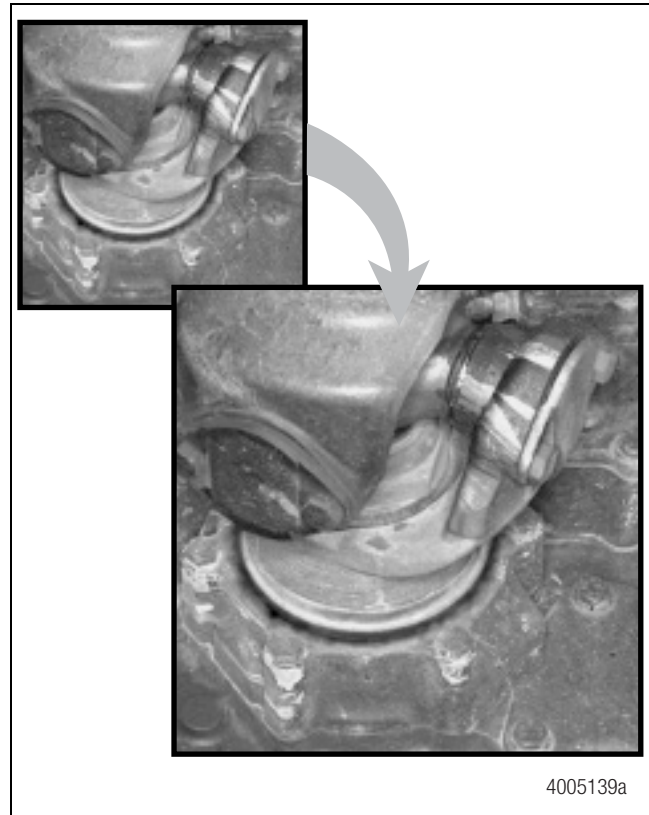

Figure 9.48

Example 2: The Seal Appears to be Leaking

Cause of Failure

A failure is possible. Inspect the seal. If a failure has occurred, determine its cause.

What To Look For

Check for an oil path from the speedometer sensor to the yoke area. If you see a path, the seal is leaking. If you don't see an oil path, but there's oil around the seal, the seal requires replacement. Both of these conditions can occur at the same time. Figure 9.49.

Check the lubricant level. If it's low, replace the seal. If not, monitor the seal for leaks.

Prevention

Follow Meritor’s recommended maintenance practices and service procedures.

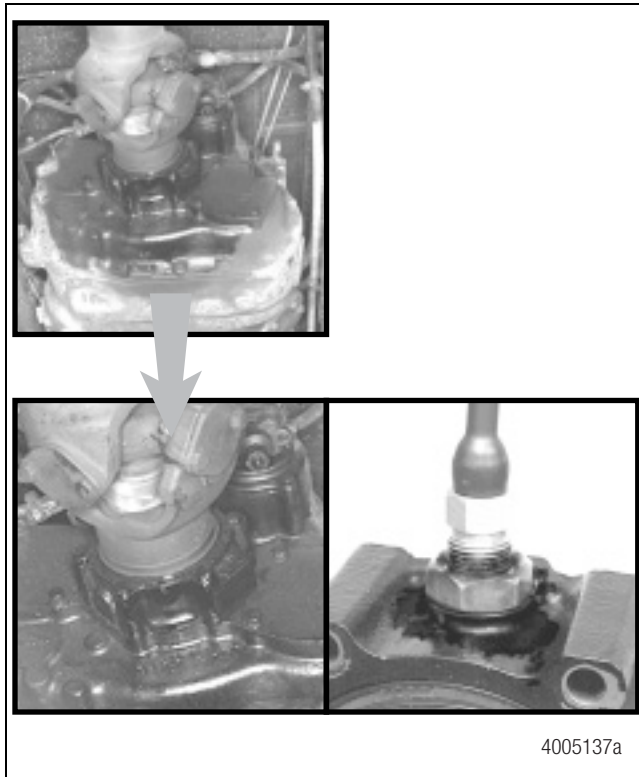

Figure 9.49

Example 3: The Seal Appears to be Leaking

Cause of Failure

A failure is possible. Inspect the seal. If a failure has occurred, determine its cause.

What To Look For

Check for an oil path from the cover bolts to the yoke area. If you see a path, the seal is leaking. If you don’t see an oil path, but there’s oil around the seal, the seal requires replacement. Both of these conditions can occur at the same time. Figure 9.50.

Clean oil and dirt from the carrier. Check the lubricant level. If it’s low, replace the seal. If not, monitor the seal for leaks.

Prevention

Follow Meritor’s recommended maintenance practices and service procedures.

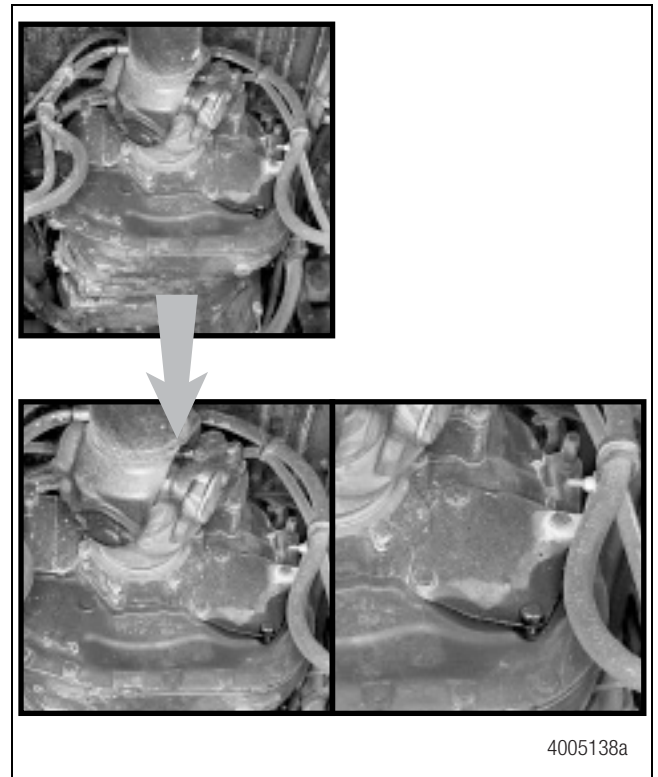

Figure 9.50

Example 4: The Seal is Leaking

Cause of Failure

Most likely, dirt or contaminants have entered the seal, or the seal’s service life is expended.

What To Look For

Inspect the yoke hub for wetness. Look for an oil leak path leading to the rear lip of the seal, which indicates that the seal is leaking and requires replacement.

The seal requires replacement, even if you don’t find an oil path from the speed sensor, shift tower and retainer bolts. Figure 9.51.

Prevention

Follow Meritor’s recommended maintenance practices and service procedures.

9 Transmissions

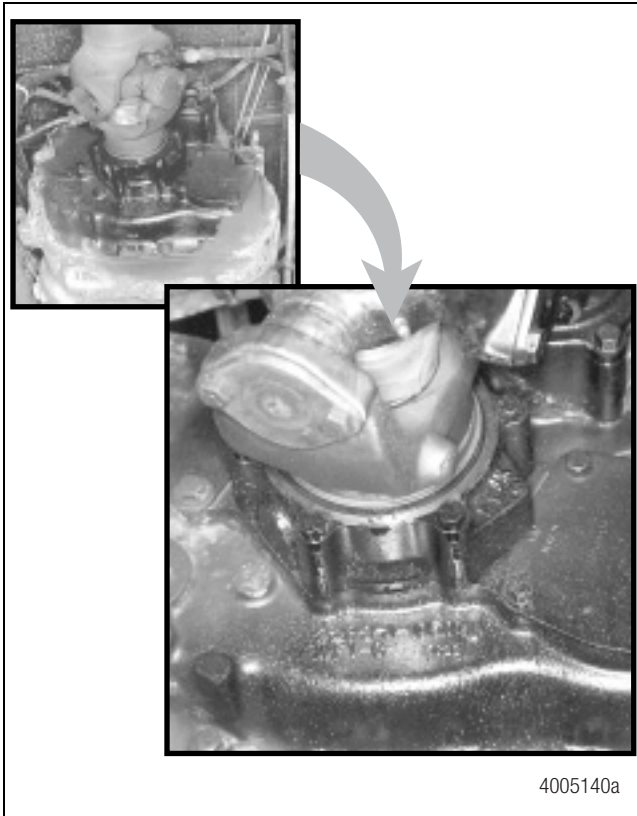

Figure 9.51

Troubleshooting and Diagnostics

Types of Problems

When checking a problem with a manual transmission, the first thing to do is to verify the service condition. Talk to the driver, the mechanic or the service manager. If possible, take the vehicle for a test drive.

There are three main types of problems.

- Leaks
- Noise and/or vibration
- Operating conditions

Use the diagnostic tables and charts provided in this section as a starting point to help diagnose the root cause of the problem. The information contained in these resources is not completely inclusive. Technicians should call the Meritor Customer Service Center at 800-535-5560 for help in diagnosing all problems on Meritor transmissions.

Oil Leaks

Check the transmission for transmission oil leaks. If you find oil on or under the transmission, verify that the leak is transmission oil and not engine oil, coolant or other lubricants.

Vibration

When checking a noise or a vibration, find out when the problem occurs.

- When the transmission is in neutral or in gear
- During upshifts or downshifts
- In all gears or specific gears
- In the high range or low range
- In direct range or overdrive range, 13-speed transmission only
- During coast or acceleration
- With the vehicle loaded or unloaded

Noise

If a noise is the problem, find out the sound of the noise.

- Growling or humming, or grinding
- Hissing, thumping or bumping
- Rattles
- Squealing
- Whining

Operating Problems

When the transmission is not operating correctly, find out when the problem occurs.

- In neutral or in gear
- During upshifts or downshifts
- In high range or low range
- In direct range or overdrive range, 13-speed transmissions only

Also, find out what the transmission does during the problem.

- Does not stay in the selected gear
- Does not stay in the selected range
- Does not select all gears
- Does not select all ranges
- Overheats
- Does not operate

Troubleshooting Other Systems

Verify that the transmission is the cause of the problem. Refer to Table E.

Table E: Diagnostics for Other Systems

System	Check For	Repairs
Engine Systems	1. Loose or missing fasteners	1. Replace missing fasteners. Tighten to the specified torque.
	2. Engine idle speed out-of-specifications	2. Adjust the idle speed to the specified range.
	3. Loose or damaged engine mounts	3. Tighten the fasteners to the specified torque. Replace the damaged mounts.
	4. Out-of-balance fan	4. Replace the fan.
	5. Damaged engine fan	5. Repair or replace as required.
Clutch Systems	1. Loose or missing fasteners	1. Replace the missing fasteners. Tighten to the specified torque.
	2. Clutch out-of-adjustment	2. Adjust the clutch.
	3. Clutch assembly out-of-balance	3. Replace the clutch assembly.
	4. Worn or damaged pilot bearing	4. Replace the pilot bearing.
Drive Shaft Systems	1. Drive shaft system requires lubrication	1. Lubricate the drive shaft system.
	2. Worn or damaged U-joints and/or yokes	2. Replace the U-joints and/or yokes.
	3. Drive shaft out-of-balance	3. Balance the drive shaft correctly or replace the drive shaft.
	4. Center bearings not installed correctly or damaged	4. Install the center bearings correctly or replace.
	5. Driveline angles not correct	5. Adjust the driveline angles to the manufacturer's specifications.
Suspension Systems	1. Loose or missing fasteners	1. Replace the missing fasteners. Tighten to the specified torque.
	2. Damaged suspension components	2. Repair or replace the damaged suspension components.
	3. Driveline touching frame	3. Adjust so that the driveline does not touch the frame.
	4. Loose or damaged cab mounts	4. Tighten loose fasteners to the specified torque. Replace the damaged mounts.
	5. Leaks in air suspension system	5. Repair the air leaks. Check all valves for correct operation.
Remote Shift Systems	1. Low lubricant level	1. Fill to the specified level.
	2. Linkage out-of-adjustment	2. Adjust the linkage.
	3. Linkage binding or unable to move	3. Lubricate, repair or replace the linkage.

9 Transmissions

Troubleshooting Leaks

Before troubleshooting a leak condition, perform the following procedures. Refer to Table F for diagnostics.

1. Clean the outside of the transmission to remove all the dirt.
2. Operate the vehicle to verify that the leak is coming from the transmission.
3. Verify that the fluid is transmission oil.
4. Verify that the transmission housings are not cracked or broken.

Table F: Troubleshooting Leaks

System	Check For	Repairs
Leaks — In-Vehicle Repair	1. Missing fasteners	1. Replace the missing fasteners. Tighten to the specified torque.
	2. Loose fasteners	2. Tighten to the specified torque.
	3. High oil level	3. Drain to the specified level.
	4. Unspecified oil in transmission	4. Drain the oil. Install the specified oil.
	5. Clogged or dirty breather vent	5. Clean the breather vent.
	6. Damaged yoke	6. Replace the yoke.
	7. Damaged output shaft seal	7. Replace the output shaft seal. ¹
Leaks — Remove and Disassemble Transmission	1. Damage gaskets or sealing material	1. Replace the gaskets or sealing material.
	2. Cracked or broken housing	2. Replace the housing.
	3. Oil leaking from breather vent. ²	3. Replace the piston shaft seal.

¹ If the transmission continues to leak and the output shaft seal and the yoke have been replaced, remove and replace the output shaft assembly.

² Place the transmission in Low Range and operate the vehicle. If air leaks from the breather vent, the range shaft seal must be replaced.

Troubleshooting Vibrations

Before troubleshooting a vibration, verify the following conditions. Refer to Table G for diagnostics.

1. The engine idle speed is within the specified range.
2. The engine is operating correctly.
3. The U-joints, yokes and drive shaft are in good condition. Check the driveline angles. Correct as necessary.
4. The U-joints, yokes and drive shafts are correctly aligned and/or balanced. Correct as necessary.
5. Check the air bag height. Correct as necessary.

Table G: Troubleshooting Vibrations

System	Check For	Repairs
Vibration — In-Vehicle Repair	1. Fasteners do not remain tight.	1. Tighten the fasteners. If the fasteners do not remain tight, replace the fasteners or the housing.
Vibration — Remove and Disassemble Transmission	1. Damaged bearings 2. Cracked or broken housing*	1. Replace the bearings. 2. Replace the synchronizer.

* If the transmission does not shift correctly into the selected range, broken or loose synchronizer pins are the result of the vibration condition.

9 Transmissions

Troubleshooting Noises

For all noise conditions, check the following before disassembling the transmission. Refer to Table H for diagnostics and for an explanation of additional repairs that may be required.

1. Check that the oil level is even with the bottom of the fill plug hole.
2. Verify that the correct oil is used.
3. Verify that the driveline angles of the transmission are correct.
4. Verify that the transmission is correctly installed.
5. Remove the drain plug. Check for any metal shavings, gasket material or any other material in the oil.

Table H: Troubleshooting Noises

Condition	Cause	Repair
Growling, Humming or Grinding¹	<ol style="list-style-type: none"> 1. Worn or damaged gears 2. Worn bearings, humming only 	<ol style="list-style-type: none"> 1. Replace the gears. 2. Replace the bearings.
Hissing, Thumping or Bumping²	<ol style="list-style-type: none"> 1. Damaged bearings, hissing only 2. Damaged gear teeth, thumping or bumping only 	<ol style="list-style-type: none"> 1. Replace the bearings. 2. Replace the gears.
Rattles — In-Vehicle Repair	<ol style="list-style-type: none"> 1. Engine idle speed not within specifications 2. Engine does not operate on all cylinders 3. Clutch intermediate or center plate binding in housing³ 4. Other systems 5. Incorrect shim installation on the PTO unit 	<ol style="list-style-type: none"> 1. Adjust the idle speed to the specified rpm. 2. Adjust or repair the engine. 3. Repair or replace the intermediate or center plate. 4. Verify that the transmission is the source of the rattle condition. 5. Install the correct shims onto the PTO unit.
Rattles — Remove and Disassemble Transmission	<ol style="list-style-type: none"> 1. Damaged washers between main shaft gears 	<ol style="list-style-type: none"> 1. Replace the washers between the main shaft gears.
Squealing or Whining — In-Vehicle Repair⁴	<ol style="list-style-type: none"> 1. Incorrect shim installation on PTO unit 	<ol style="list-style-type: none"> 1. Install the correct shims onto the PTO unit.
Squealing or Whining — Remove and Disassemble Transmission⁴	<ol style="list-style-type: none"> 1. Damaged bearings 2. End play of countershafts not within specifications 	<ol style="list-style-type: none"> 1. Replace the bearings. 2. Adjust the countershaft end play within specifications.

¹ Growling and humming are associated with the first stages of the condition. Grinding is associated with the severe stages of the condition.

² Hissing is associated with the first stages of the condition. Thumping and bumping are associated with the severe stages of the condition.

³ If the noise occurs when the clutch is engaged and stops when the clutch is disengaged, the intermediate or center plate is the cause of the rattle.

⁴ Whining is a medium-pitched noise. Squealing is a high-pitched noise.

Troubleshooting Operating Conditions

Refer to Table I to troubleshoot operating conditions. For all Range Shift System diagnostics, refer to the flowcharts in this section.

Table I: Operating Conditions

Condition	Cause	Repair
Transmission Slips Out of the Selected Range — In-Vehicle Repair¹	<ol style="list-style-type: none"> 1. The air lines and fittings are loose. 2. Obstructions are in the air lines. 3. Check the operation of the filter/regulator assembly. 4. The range piston is damaged. 5. The nut that fastens the piston to the shift shaft in the range shift cylinder is loose or missing. 	<ol style="list-style-type: none"> 1. Tighten the air lines and fittings. 2. Change the routing or replace the air lines. 3. Replace the filter/regulator assembly if the pressure at the delivery port is not within specification. 4. Replace the range piston. 5. Tighten or replace the nut.
Transmission Slips Out of the Selected Range — Remove and Disassemble Transmission¹	<ol style="list-style-type: none"> 1. The teeth in the sliding clutch are worn. 2. The shift fork is bent or worn. 3. The collar on the range shift fork is worn. 	<ol style="list-style-type: none"> 1. Replace the sliding clutch. 2. Replace the shift fork. 3. Replace the collar on the range shift fork.
Transmission is Slow to Shift or Unable to Shift into the Selected Range — In-Vehicle Repair¹	<ol style="list-style-type: none"> 1. The air lines and fittings are loose or leaking. 2. Obstructions are in the air lines. 3. The filter/regulator assembly does not operate correctly. 4. The piston or O-rings in the piston housing are damaged. 5. The neutral switch is worn or damaged. 6. The shift knob is damaged. 	<ol style="list-style-type: none"> 1. Tighten or replace the air lines or fittings. 2. Change the routing or replace the air lines. 3. Replace the filter/regulator assembly if pressure at the delivery port is not within specification. 4. Replace the piston or damaged O-rings. 5. Test and replace the neutral switch. 6. Test and replace the shift knob.
Transmission is Slow to Shift or Unable to Shift into Selected Range — Remove and Disassemble Transmission¹	<ol style="list-style-type: none"> 1. The output shaft is damaged. 2. The synchronizer springs or pins are broken or missing. 3. The synchronizer is damaged. 4. The shift shaft in the range cylinder is bent or broken. 5. The shift fork in the range cylinder is bent or broken. 	<ol style="list-style-type: none"> 1. Replace the output shaft. 2. Replace the synchronizer springs or synchronizer. 3. Replace the synchronizer. 4. Replace the shift shaft. 5. Replace the shift fork.

9 Transmissions

Condition	Cause	Repair
Transmission Slips Out of the Selected Gear — In-Vehicle Repair	<ol style="list-style-type: none"> 1. The clutch is used incorrectly. 2. The linkage is binding or does not move freely. 3. The clutch is out-of-adjustment. 4. The remote shift linkage is out-of-adjustment. 5. The engine or cab mounts are loose or damaged. 6. The driveline angles are incorrect. 7. The detent spring in the top cover is weak or broken. 	<ol style="list-style-type: none"> 1. Ensure that the driver uses the clutch correctly. 2. Lubricate, repair or replace the linkage. 3. Adjust the clutch. Ensure that the clutch engages and releases correctly. 4. Adjust the remote shift linkage. 5. Tighten the fasteners on the loose mounts to the specified torque. Replace the damaged mounts. 6. Adjust the driveline angles. 7. Replace the detent spring in the top cover assembly.
Transmission Slips Out of the Selected Gear — Remove and Disassemble Transmission	<ol style="list-style-type: none"> 1. The pads on the shift fork are worn. 2. The teeth in the sliding clutch are worn. 3. The fork slot on the sliding clutch is worn. 4. The key on the main shaft is broken. 5. The main shaft is twisted. 	<ol style="list-style-type: none"> 1. Replace the shift fork. 2. Replace the sliding clutch. 3. Replace the sliding clutch. 4. Replace the key or main shaft. 5. Replace the main shaft.
Transmission is Hard to Shift or Unable to Shift into the Selected Gear — In-Vehicle Repair	<ol style="list-style-type: none"> 1. The vehicle is operated incorrectly. 2. The clutch is out-of-adjustment. 3. The remote shift linkage is binding or unable to move. 4. The cab or engine mounts are loose or damaged. 5. The detent spring is too strong or broken. 	<ol style="list-style-type: none"> 1. Ensure that the driver operates the vehicle correctly. 2. Adjust the clutch. Ensure that the clutch engages and releases correctly. 3. Lubricate, repair or replace the remote shift linkage. 4. Tighten the fasteners of the loose mounts to the specified torque. 5. Replace the detent springs.
Transmission is Hard to Shift or Unable to Shift into the Selected Gear — Remove and Disassemble Transmission	<ol style="list-style-type: none"> 1. Bent shift shaft in top cover assembly 2. Burr on the shift shaft in the top cover assembly 3. Cracked top cover assembly 4. The main shaft is twisted. 5. The key on the main shaft is broken. 6. Broken or bent shift fork on the sliding clutch 	<ol style="list-style-type: none"> 1. Replace the shift shaft. 2. Replace the shift shaft. 3. Replace the top cover assembly. 4. Replace the main shaft. 5. Replace the key or the main shaft. 6. Replace the fork.

Condition	Cause	Repair
Transmission Grinds on Initial Engagement — In-Vehicle Repair	<ol style="list-style-type: none"> 1. The driver does not operate the vehicle correctly. 2. The clutch is out-of-adjustment. 3. The clutch brake is worn, damaged or missing. 4. The clutch or remote shift housing linkage is binding or unable to move. 5. Worn bushings in side of clutch housing 	<ol style="list-style-type: none"> 1. Ensure that the driver operates the vehicle correctly. 2. Adjust the clutch. Verify that the clutch engages and releases correctly. 3. Replace the clutch brake. Verify that the clutch engages and releases correctly. 4. Lubricate, repair or replace the linkage. 5. Replace the bushings in the clutch housing.
Shift Lever Locks or Sticks in Gear — In-Vehicle Repair	<ol style="list-style-type: none"> 1. The remote shift linkage is out-of-adjustment. 2. The clutch linkage needs adjustment. 3. The linkage is binding or unable to move. 4. The cab or engine mounts are loose or damaged. 5. The shift stub lever is not engaged in the shift sleeve. 	<ol style="list-style-type: none"> 1. Adjust the remote shift linkage. 2. Adjust the clutch linkage. 3. Lubricate, repair or replace the linkage. 4. Tighten the fasteners on the loose mounts to the specified torque. Replace the damaged mounts. 5. Reinstall the shift tower and verify the engagement of the stub lever into the shift sleeve.
Shift Lever Locks or Sticks in Gear — Remove and Disassemble Transmission	<ol style="list-style-type: none"> 1. The shift fork in the top cover is bent. 2. The shift shaft in the top cover is damaged. 3. The main shaft is damaged. 	<ol style="list-style-type: none"> 1. Replace the shift fork. 2. Replace the shift shaft. 3. Replace the main shaft.
Transmission Overheats — In-Vehicle^{2, 3}	<ol style="list-style-type: none"> 1. The oil level is incorrect. 2. Incorrect oil 3. The temperature gauge is damaged.⁴ 	<ol style="list-style-type: none"> 1. Fill the oil to the specified level. 2. Drain the oil. Use the specified oil. 3. Replace the temperature gauge.
Transmission Does Not Operate — Remove and Disassemble Transmission	<ol style="list-style-type: none"> 1. The free running gears are locked. 2. The gear sets are mismatched. 3. The timing marks on the gears are not aligned. 4. The shafts are broken. 	<ol style="list-style-type: none"> 1. Replace the gears. 2. Install the correct gear sets. 3. Align the timing marks on the gears. 4. Replace the shafts.

¹ Also refer to the Range Shift System diagnostic flowcharts in this section to troubleshoot all range system problems.

² If a noise is present along with the overheating condition, also refer to the noise troubleshooting table in this section.

³ If the oil is at the specified level and the specified oil is used, but the transmission overheats and the oil smells burned, the transmission must be disassembled and inspected.

⁴ If the oil does not have a burned smell and the temperature gauge indicates overheating, remove and replace the gauge.

9 Transmissions

Range Shift System Diagnostics for Platform G Transmissions

These flowcharts provide diagnostic information for ZF-FreedomLine Platform G transmission range shift systems. When using diagnostics to troubleshoot system faults, it's important to follow these flowcharts step-by-step and use the diagnostic procedures in the sequence outlined below. Figure 9.52, Figure 9.53 and Figure 9.54.

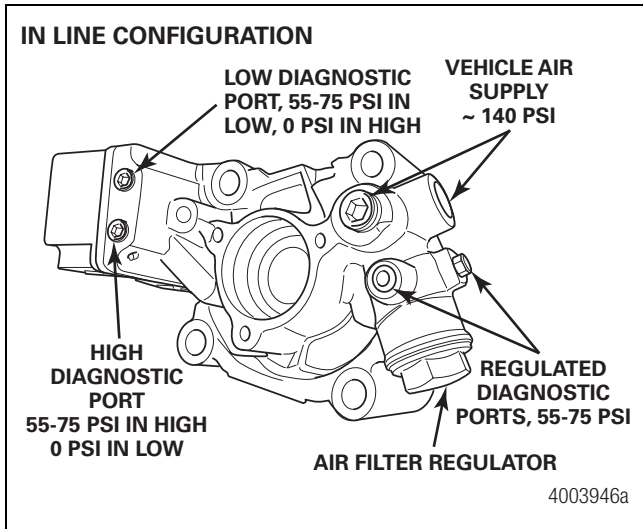

Figure 9.52

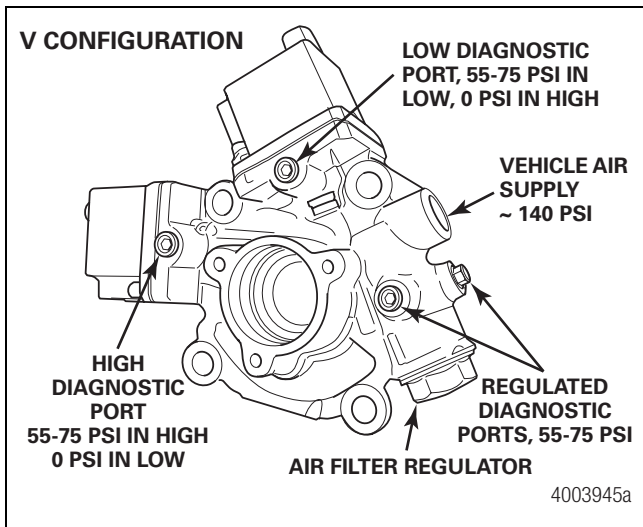

Figure 9.53

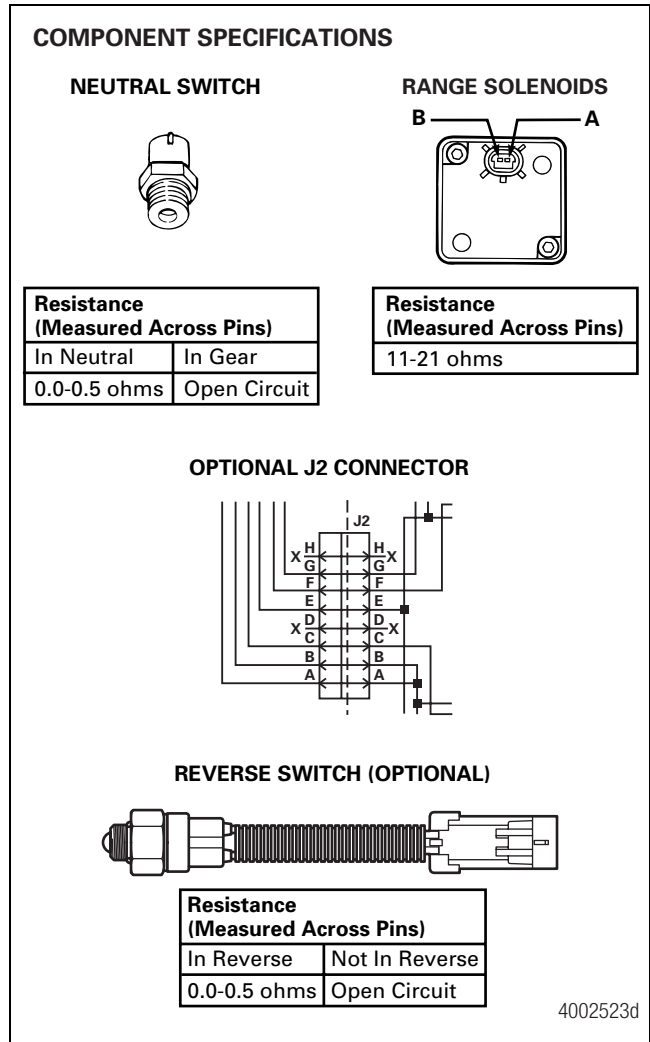

Figure 9.54

1. Mechanical Checks — Follow the mechanical checks flowchart to verify that all mechanical systems function correctly. Repair all mechanical issues BEFORE you perform electrical checks. Figure 9.55.

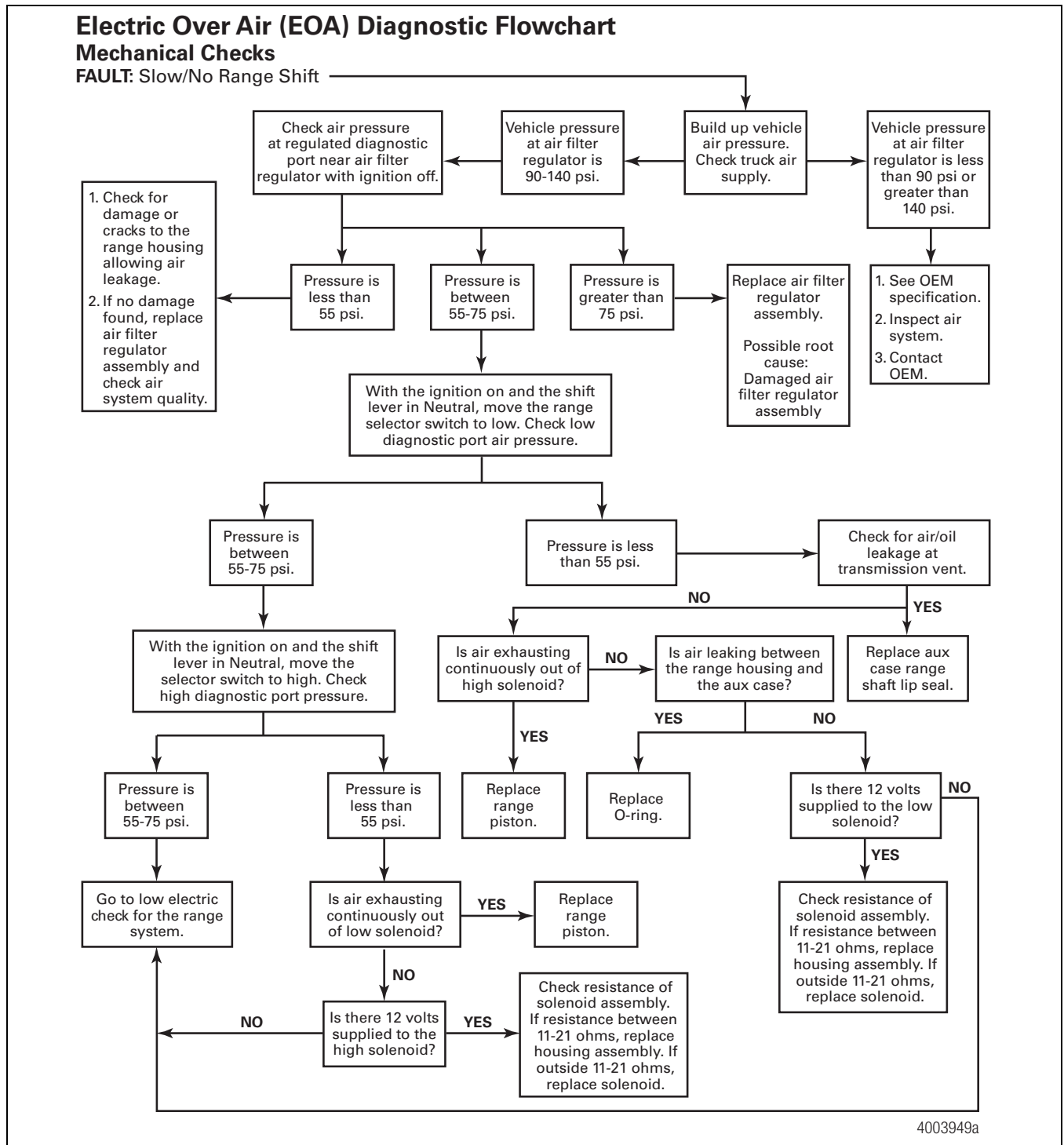

Figure 9.55

9 Transmissions

2. Low Range Electrical Checks — Follow the low range electrical checks flowchart to verify that the low electrical system functions correctly. Perform low range electrical checks AFTER mechanical checks and BEFORE high range electrical checks. Figure 9.56.

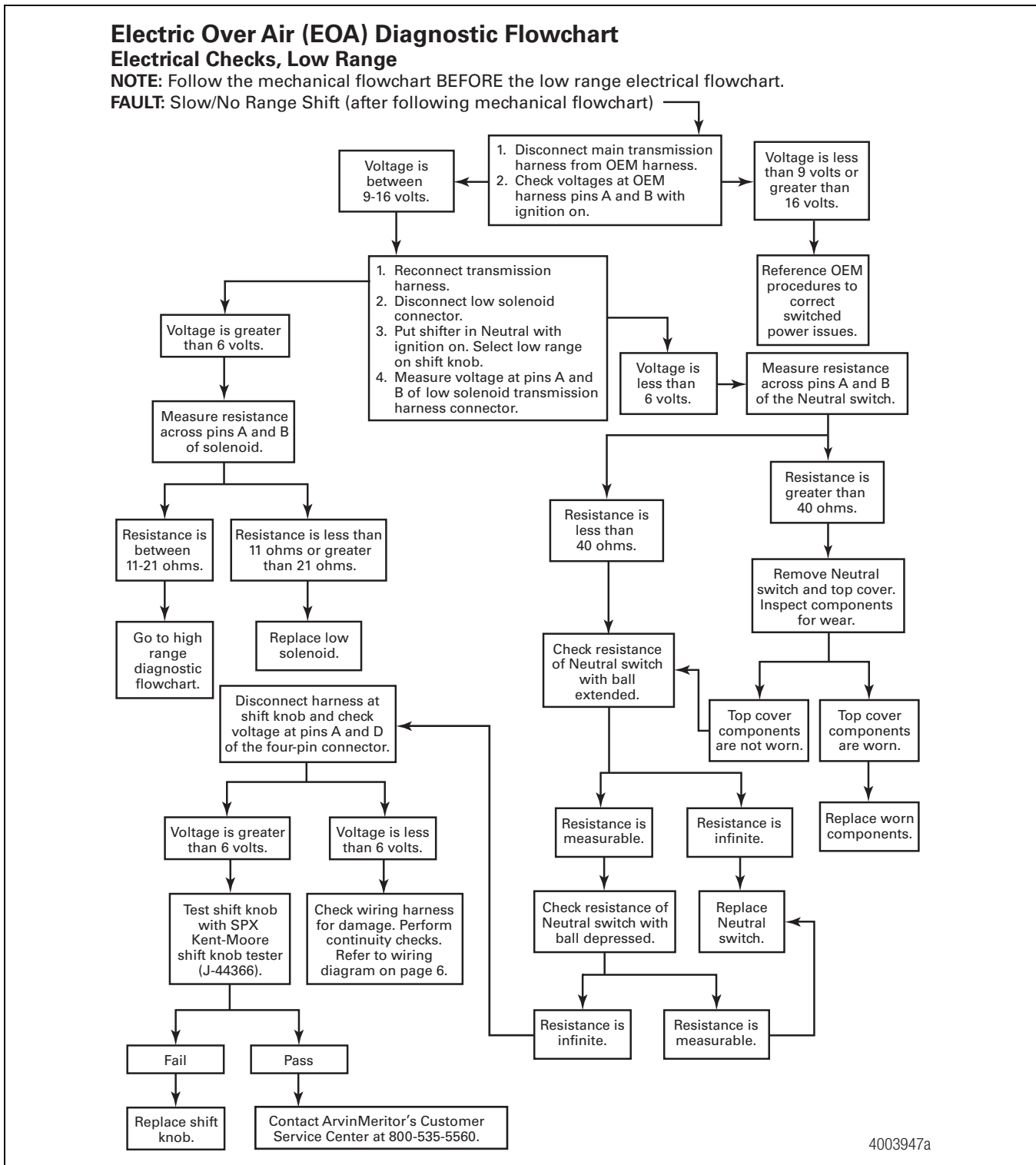

Figure 9.56

3. High Range Electrical Checks — Follow the high range electrical checks flowchart to verify that the high range electrical system functions correctly. Perform high range electrical checks AFTER mechanical checks and low range electrical checks. Figure 9.57.

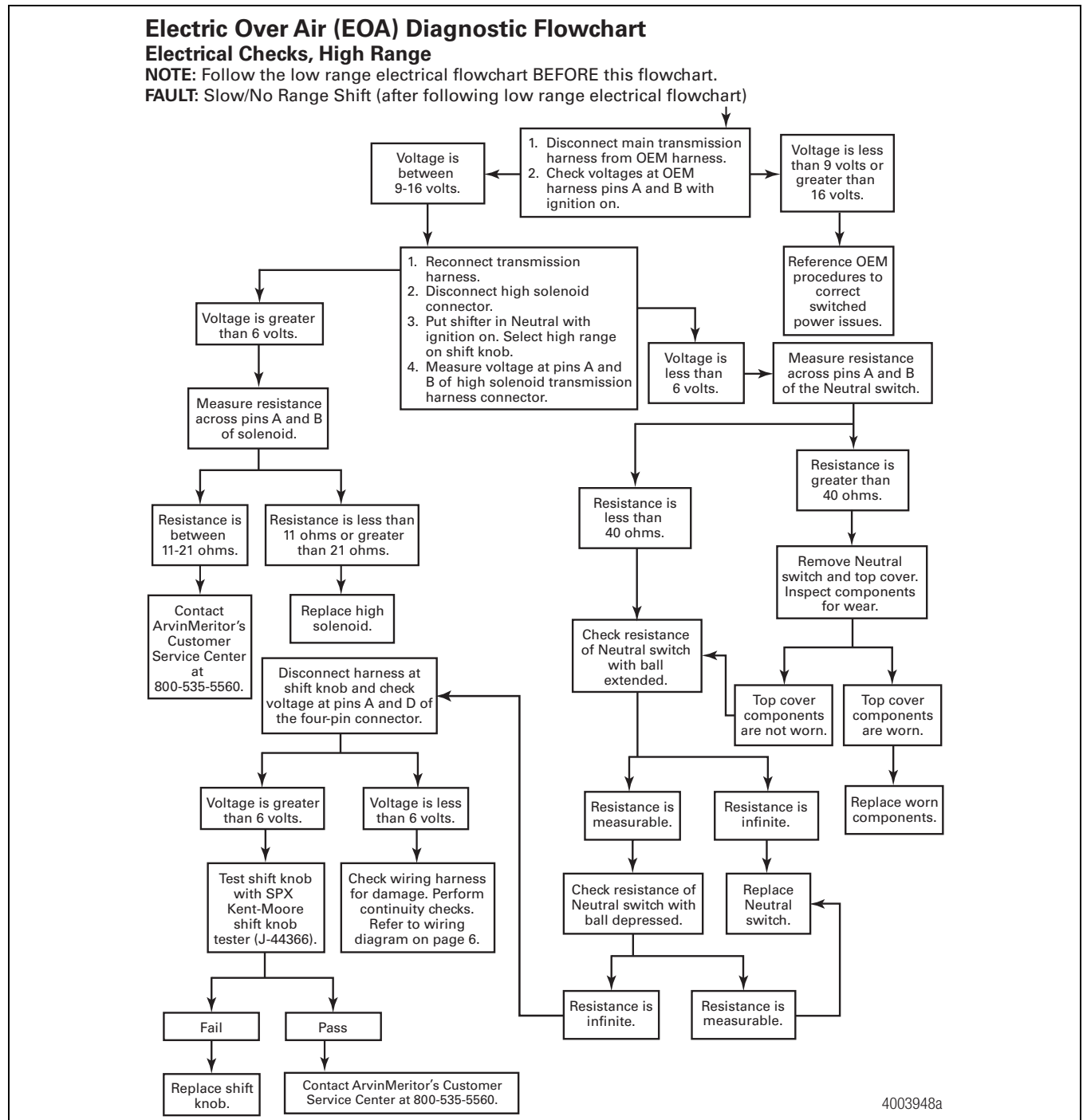

Figure 9.57

When you find the fault, follow the recommended service procedures to repair it and then test the system. If a fault still exists, or if you find a new one, repeat Steps 1-3 above until you've repaired all the faults.

10 Transfer Cases

Parts Analysis Overview

Evaluate Damaged Transfer Case

⚠ WARNING

To prevent serious eye injury, always wear safe eye protection when you perform vehicle maintenance or service.

This section provides a parts analysis process to help you determine why transfer cases failed during operation, what to look for when you inspect the parts, and how to help prevent failures from occurring again.

Most of the time, you can find the answers you need by visually inspecting a failed component. Sometimes, however, this process may require specialized knowledge or equipment.

Why a product fails can be difficult to determine, and a failure can vary in appearance from vehicle to vehicle. Failures in models from the same manufacturer can also vary, so it is important to use the information presented here as a guide, not a rule, when you perform parts analysis inspections.

Front Idler Bearing

Cause of Failure

Incorrect towing from the front of the vehicle without removing the drive shaft from the rear output shaft of the transfer case to the rear drive axle, or not removing the rear drive axle shafts on the tires that contact with the road.

What To Look For

You find damage to the front idler bearing caused by lack of lubrication. Figure 10.1.

You find damage to the front idler bearing cone and/or rollers caused by heat and/or lack of lubrication. Figure 10.1 and Figure 10.3.

You find damage to the front idler cup caused by heat and/or lack of lubrication. Figure 10.2.

The bearing cage is destroyed. Figure 10.3.

The input shaft surface and phosphate coating for the low gear bearing journal show eccentric wear, which means wear shows on approximately 180 degrees of the bearing journal, but not on the 180 degrees of the opposite side of the input shaft journal. This condition indicates the low gear is rotating, but the input shaft is not rotating; or the input shaft is rotating at a slower speed during towing. Figure 10.4.

There could be signs of gear clash wear at the end of the high/low clutch collar teeth on the high gear side. This is caused by the inclination of the vehicle as it loses air during towing. Figure 10.5 and Figure 10.6.

Usually, there are no other signs of heat present on other bearings. This damage can occur when the transfer case is rotating, and oil is not flowing from the lubrication pump. If the input shaft on the transfer case is not rotating, the oil pump and/or lubricant splash does not reach the bearings during vehicle inclination while towing. Insufficient lubricant resulting from incorrect towing procedures will damage the front idler bearing. The transfer case can fail during towing, or when the vehicle is in operation.

Prevention

Follow the vehicle towing instructions in Maintenance Manual MM-0146, Transfer Cases MTC-4208, -4210 and -4213, for the MTC-4208 and MTC-4210 transfer case product models.



Figure 10.1



Figure 10.2

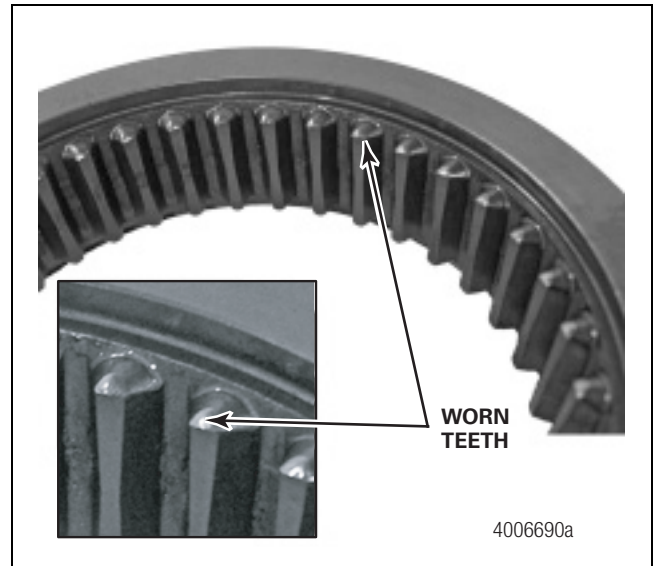

Figure 10.5

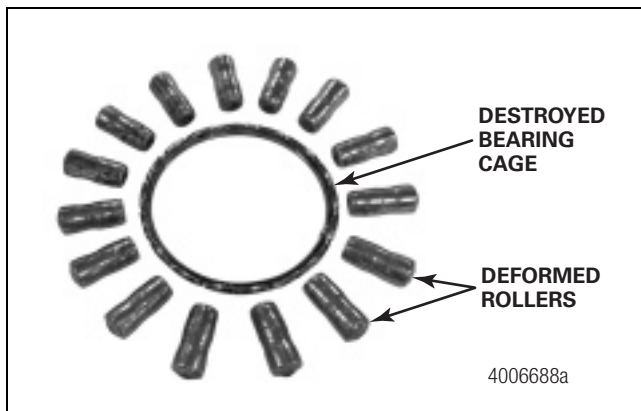

Figure 10.3

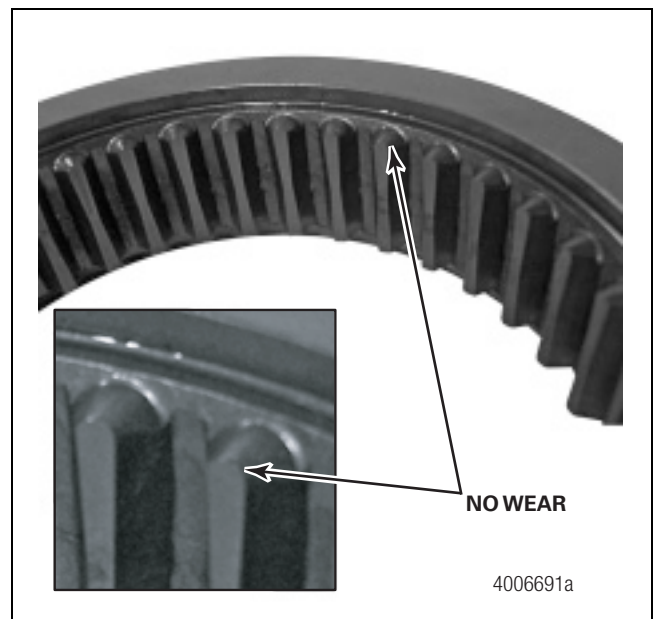

Figure 10.6

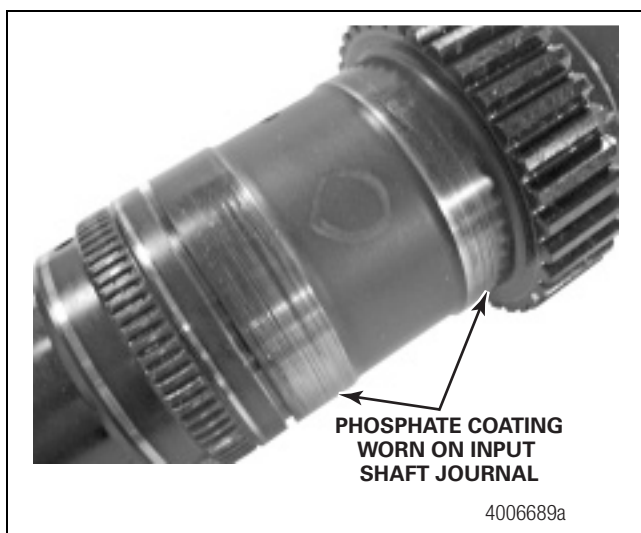

Figure 10.4

Front Output Shaft

Cause of Failure

Incorrect towing from the rear of the vehicle without removing the prop shaft from the transfer case to the axle with the wheels on the road. This will cause a spinout condition between the front output helical gear and the front output shaft.

10 Transfer Cases

What To Look For

Front output shaft and gear spinout damage caused from friction welding. Figure 10.7.

Front output shaft rear bearing cup is damaged from heat. Figure 10.8.

Front output shaft bearing cup and cage is completely destroyed from heat. Figure 10.8.

There is no damage to the All Wheel Drive (AWD) clutch collar because it was not engaged. Heat from the other parts caused slight discoloration of the clutch collar. Figure 10.9.

Spinout between the front output shaft journal and the front output shaft gear caused a friction welding of the two components as well as damage to the front output shaft bearing.

No signs of wear on the front input shaft from the oil pump sealing rings indicate the input shaft was not turning during towing. Figure 10.10.

This damage is caused by the transfer case turning during towing. The transfer case may fail during towing or while driving the vehicle after it has been incorrectly towed.

Prevention

Follow the vehicle towing instructions in Maintenance Manual MM-0146, Transfer Cases MTC-4208, -4210 and -4213, for the MTC-4208 and MTC-4210 transfer case product models.

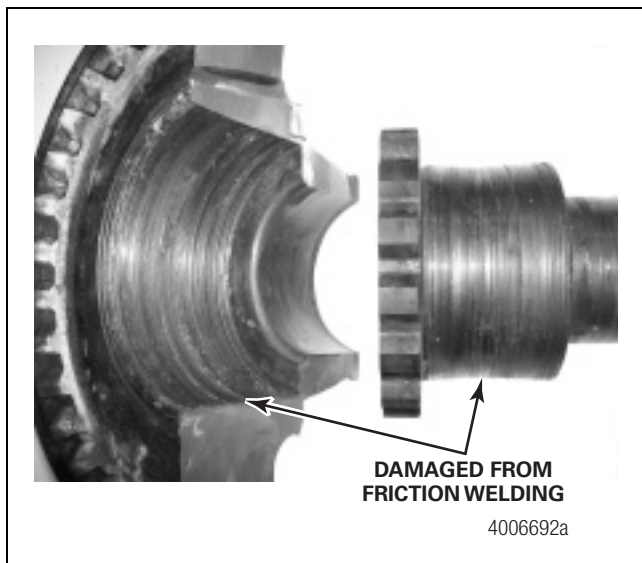

Figure 10.7



Figure 10.8



Figure 10.9

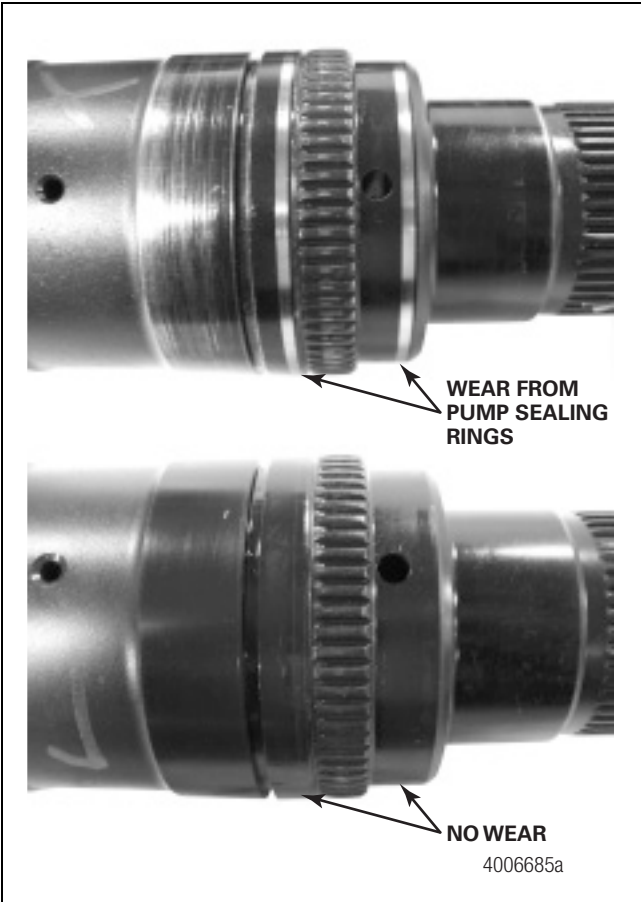

Figure 10.10

Meritor Heavy Vehicle Systems, LLC
2135 West Maple Road
Troy, MI 48084 USA
800-535-5560
arvinmeritor.com

Copyright 2008
ArvinMeritor, Inc.

Printed in USA

Revised 04-08
Manual TP-0445 (16579/22882)

ArvinMeritorTM